

RD[®] pile wall

Design and installation manual

This manual deals with retaining wall solutions using drilled RD[®] piles and manufactured by SSAB. The manual is based on EN standards.

The manual presents the basics of RD pile wall design and installation, recommendations for choosing the most suitable pile size and connector type, instructions for handling and installation, as well as instructions for quality control, measurements and documentation.

The manual also includes pre-calculated tables and implementation examples to facilitate the design and execution of an RD pile wall solution.

Applications:

- permanent retaining walls
- structures under combined lateral and vertical loads
- bridge abutments
- basement parking facilities
- watertight retaining walls
- retaining walls and excavations extending to bedrock

Pile pipes:



ETA 12/0526

Contents

1	SCOPE	3
1.1	Application examples	3
2	NORMATIVE REFERENCES	6
3	TERMS AND DEFINITIONS	6
4	INFORMATION NEEDED FOR THE EXECUTION OF RD PILE WALLS	7
4.1	General	7
4.2	Specific	7
4.3	Execution classes	8
5	SITE INVESTIGATIONS	8
5.1	Geotechnical investigations	8
6	MATERIALS AND ACCESSORIES	9
6.1	Pile pipes	9
6.2	Connectors	9
6.3	Drill bits	10
6.4	Sealants for connectors	11
6.5	Other materials and accessories	11
7	DESIGN OF RD PILE WALL STRUCTURES	12
7.1	General	12
7.2	Selecting pile size	12
7.3	Connector selection	17
7.4	Water tightness and groundwater management	18
7.5	Other structural components	20
7.6	Working order	22
7.7	Special aspects to consider in design	23
8	EXECUTION OF RD PILE WALL STRUCTURES	23
8.1	General	23
8.2	Site preparation	24
8.3	Storage and handling of pile pipes	24
8.4	Welding and cutting of steel elements	24
8.5	Drilling of pile pipes	26
8.6	Tolerances regarding plan position and verticality	27
8.7	Pile pipe position during drilling	28
8.8	Installation of anchorages	28
8.9	Walings and struts	28
8.10	Excavation, filling, drainage and de-watering	28
8.11	Extraction of pile pipes	28
8.12	Rock dowels and anchor bolts	28
8.13	Sealing	28
8.14	Surface treatments and linings	29
9	SUPERVISION, TESTING AND MONITORING	29
9.1	Supervision	29
9.2	Testing	29
9.3	Monitoring	29
10	CONSTRUCTION SITE DOCUMENTATION	30
10.1	Installation phase worksite documents	30
10.2	Final phase worksite documents	30
11	SPECIAL REQUIREMENTS	30
11.1	Safety	30
11.2	Impact on surrounding buildings and installations	31
11.3	Noise hindrance	31
11.4	Permeability of retaining walls	31

1 Scope

The RD® pile wall is based on SSAB's spirally- or longitudinally-welded steel pipe piles and connectors attached by welding at the mill. The piles are drilled by the concentric drilling method. The connector profiles have been especially purpose engineered and -designed by SSAB. The matching dimensions of ring bits and connectors allow RD pile walls to be installed by drilling through stones and boulders and even into the bedrock, if necessary. A larger than normal ring bit is used to drill a hole larger than the outer diameter of the pile in soil, stones and bedrock.

Permanent structures

RD pile walls are best suited for permanent structures that require high vertical and horizontal resistances. RD pile walls can also be installed reliably under challenging conditions, whereby the solution brings considerable savings in construction time and produces an end result of good overall economy. RD pile walls may even completely eliminate the need to build temporary retaining walls.

Temporary structures

As a temporary retaining wall structure during construction, an RD pile wall is particularly suitable for challenging soil conditions, where it is difficult or impossible to use conventional retaining wall structures.

Horizontally loaded structures

An RD pile wall is an excellent solution for projects that require higher bending stiffness and resistance than conventional sheet pile walls can offer. An RD pile wall built using large diameter RD piles provides high bending stiffness and resistance.

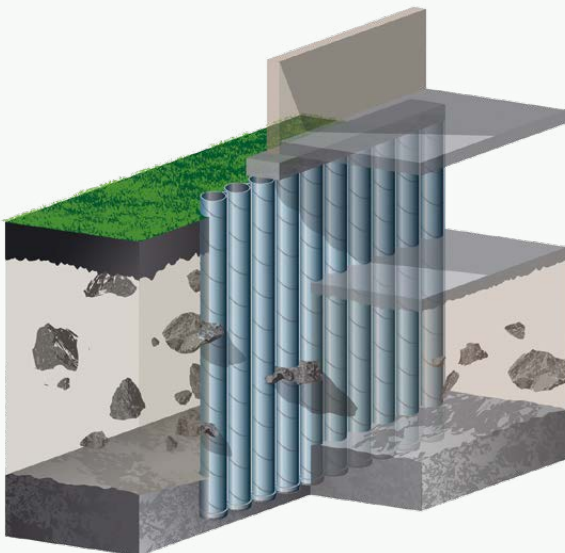

Figure 1. RD pile wall in a building with a basement.

Vertically loaded structures

If the piles are extended to the bedrock, the vertical resistance of the RD pile wall is very high. Thus the structure can act as a horizontally loaded wall subject to earth pressure and a foundation structure able to bear high vertical loads at the same time.

1.1 Application examples

Building with a basement

An RD pile wall may be used to good advantage in buildings with one or more basement storeys. In such projects, the RD pile wall serves as a permanent joint structure for vertical and horizontal loads. The solution is cost effective because no separate retaining wall structures are needed. An RD pile wall can be surface treated and allowed to remain an exposed wall structure, for example, in parking facilities in a basement without internal cladding. Figure 1 shows an example of an RD pile wall in a building with a basement.

Building with a column frame

An RD pile wall may consist of piles of variable lengths. Some of the piles of the RD pile wall can be extended to the bedrock to ensure horizontal support for the lower end of the wall structure, and to act as foundation piles that transport column loads. Figure 2 shows an example of an RD pile wall in a building with a column frame.

An RD pile wall may also be built as a so-called Combi wall, with sheet piles installed between the RD piles fitted with connectors by driving them by impact driving or vibration after installation of the pipe piles.

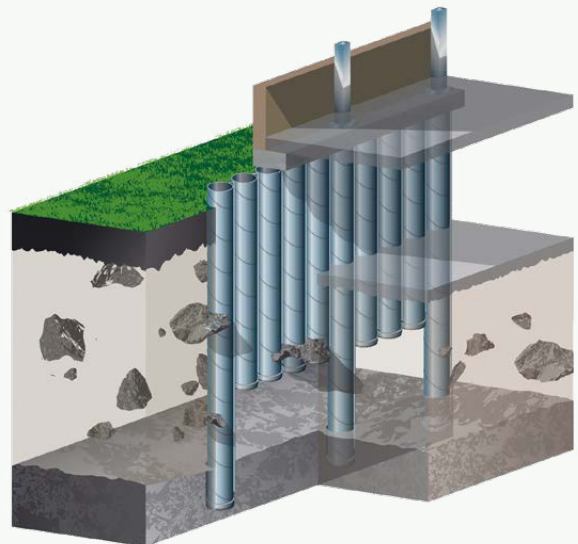

Figure 2. RD pile wall in a building with a column frame.

Temporary retaining wall during construction

An RD pile wall is an effective solution for temporary retaining wall structures during construction in conditions where the soil contains strata that are difficult to penetrate, high water tightness is required of the retaining wall, there is a need to minimize the number of support levels, or the retaining wall must be extended into the bedrock. Installation of RD pile walls usually causes less vibration when penetrating compact soil layers than the installation of sheet pile walls. This makes the RD pile wall very suitable for installation close to vibration-sensitive structures. Figure 3 shows an example of the RD pile wall as a temporary retaining wall during construction.

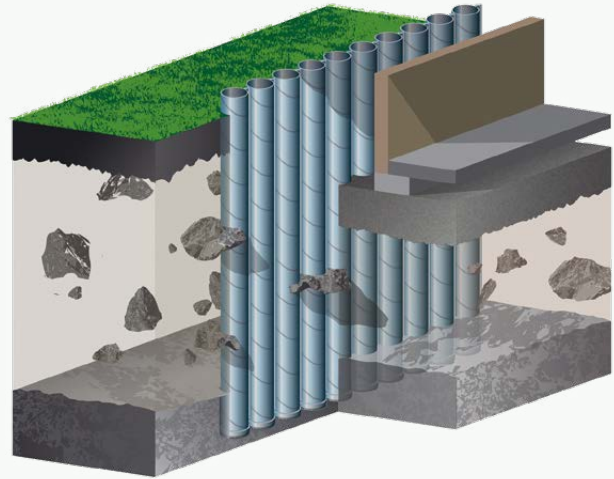

Figure 3. RD pile wall as a temporary retaining wall during construction.

Retaining walls of various shapes

RD pile walls may be used for building wall assemblies of different geometric shapes. For instance, the walls can be circular or make angles of various degrees. If necessary, an RD pile wall can consist of a combination of different pile sizes. This enables the wall structure to be optimized according to actual loads. Figure 4 shows an example of an RD pile wall used as a retaining wall of different shape.

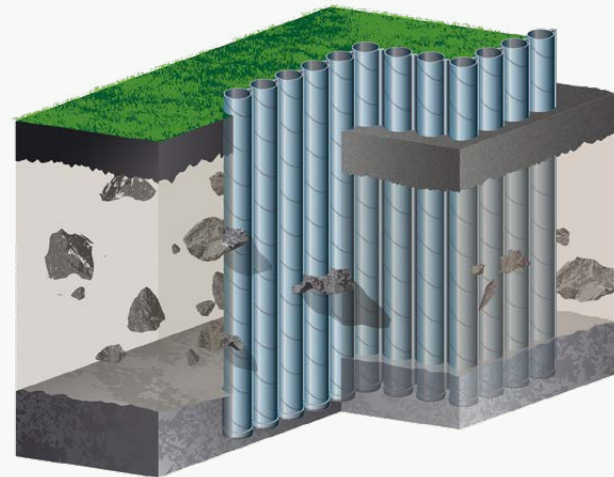

Figure 4. RD pile wall as a retaining wall of different shape.

Excavations and structures extending into the bedrock

If the support of the bottom of the retaining wall, the excavation level or water tightness requires the retaining wall to be extended securely into the bedrock or several meters into moraine containing stones and boulders, sheet pile walls cannot be used without special measures such as pre-drilling, blasting, etc. A temporary or permanent RD pile wall can be drilled to the desired level in the bedrock. The rock bounded by the wall may be excavated up to the wall, whereby construction work requires less space because there is no need for a “rock shelf” on which the retaining wall rests. Figure 5 shows an example of an RD pile wall as an excavation wall extending into the bedrock.

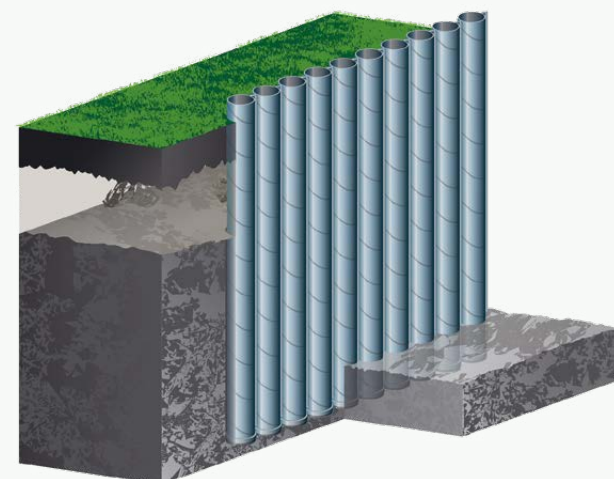

Figure 5. RD pile wall as an excavation wall extending into the bedrock.

Bridge abutments

An RD pile wall can be used as a bridge abutment (Figure 6). With the RD pile wall, the vertical and lateral loads of the bridge and the horizontal loads of the embankment can be transferred reliably to the bedrock and soil. Use of an RD pile wall as an abutment allows the bridge deck to be built before excavation. This can be combined, for instance, with a method to move the deck to minimize traffic disruption during construction.

Intermediate bridge supports

RD pile walls can be used for intermediate bridge supports subject to heavy horizontal loads, such as impact loads, under difficult soil and environmental conditions. A closed frame extending into the bedrock can be built with an RD pile wall under an intermediate column and the soil removed from top part for concreting (Figure 7). The structure does not require separate temporary retaining structures during construction and the foundations can be implemented in cramped conditions.

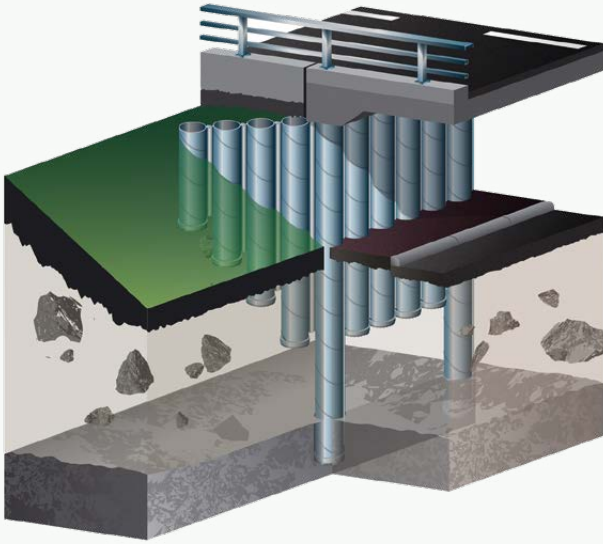

Figure 6. RD pile wall as a bridge abutment.



Figure 7. RD pile wall as intermediate collision-load bridge support.

Harbor wharves

RD pile walls can be used for building wharves in challenging soil conditions. If necessary, the piles can be protected against corrosion, for example, by painting as shown in Figure 8. An RD pile wall can be built of SSAB's high strength piles of grade S550J2H steel. A high-strength steel grade provides the structure with high bending resistance in relation to material consumption.

Wind turbine foundations

RD pile walls can be used to build integral foundation wall structures for off-shore facilities. The RD pile wall foundation is particularly suitable for conditions where the installation of large mono-piles requires special measures or, for example, a caisson foundation would require massive soil replacement. An RD pile wall foundation allows wind turbines to be built also in shallow water in all soil conditions as shown in Figure 9.

Trough structures

RD pile walls can be used to implement watertight trough structures which allow, for example, a road to be built below groundwater level without lowering the surrounding groundwater table. If RD piles are extended watertightly into the bedrock (Figure 10), there is no need to anchor the foundation slab of the trough structure against buoyancy. In temporary retaining walls during construction, pipe piles can be used as temporary pump wells to keep excavation dry.

2 Normative references

These instructions incorporate references from other publications. These references are cited at the appropriate places in the text and the publications are listed hereafter.

EN 1011-2 Welding. Recommendations for welding of metallic materials. Part 2: Arc welding of ferritic steels

EN 1090-2 Execution of steel structures and aluminium structures. Part 2: Technical requirements for steel structures

EN 1990 Eurocode. Basis of structural design

EN 1993-1-1 Eurocode 3: Design of steel structures. Part 1-1: General rules and rules for buildings

EN 1993-5 Eurocode 3: Design of steel structures – Part 5: Piling

EN 1997-1 Eurocode 7: Geotechnical design – Part 1: General rules

EN 10020 Definitions and classification of grades of steel

EN 10204 Metallic products. Types of inspection documents

EN 10219-1 Cold formed structural welded hollow sections of non-alloy and fine grain steels – Part 1: Technical delivery requirements

EN 10219-2 Cold formed welded structural hollow sections of non-alloy and fine grain steels – Part 2: Tolerances, dimensions and sectional properties

EN 10248-1 Hot rolled sheet piling of non alloy steels. Part 1: Technical delivery conditions

EN 12063 Execution of special geotechnical work. Sheet pile walls, combined pile walls, high modulus walls

EN 16228-1 Drilling and foundation equipment. Safety. Part 1: Common requirements

EN 16228-2 Drilling and foundation equipment. Safety. Part 2: Mobile drill rigs for civil and geotechnical engineering, quarrying and mining

EN 16228-7 Drilling and foundation equipment. Safety. Part 7: Interchangeable auxiliary equipment

EN ISO 3834-3 Quality requirements for fusion welding of metallic materials - Part 3: Standard quality requirements

EN ISO 4063 Welding, brazing, soldering and cutting. Nomenclature of processes and reference numbers

EN ISO 9001 Quality management systems. Requirements

EN ISO 9692-1 Welding and allied processes. Types of joint preparation. Part 1: Manual metal arc welding, gas-shielded metal arc welding, gas welding, TIG welding and beam welding of steels

EN ISO 12944 Paints and varnishes – Corrosion protection of steel structures by protective paint systems - Parts 1 to 9

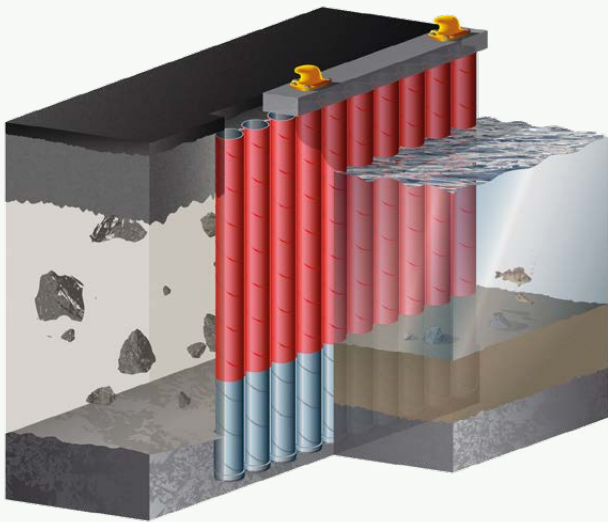

Figure 8. Corrosion-protected RD pile wall as a harbor wharf.

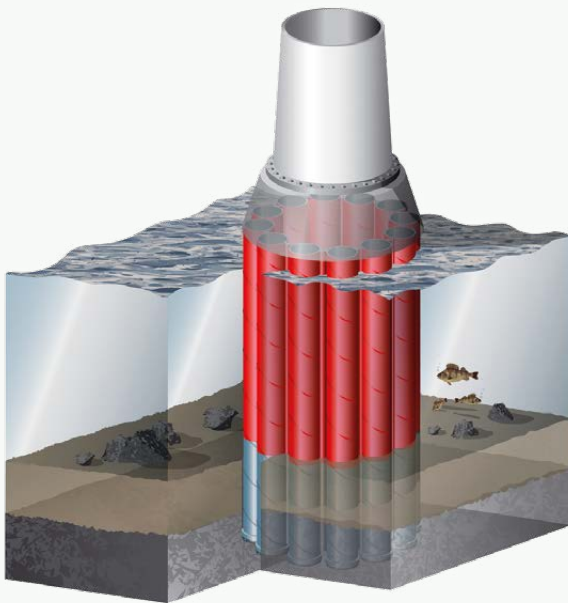

Figure 9. Corrosion-protected RD pile wall as wind turbine foundation.

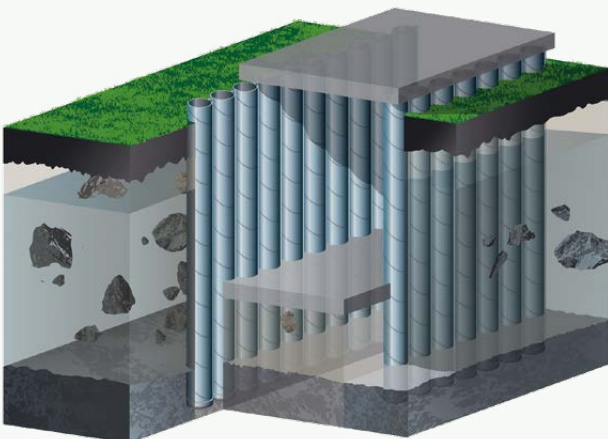

Figure 10. Watertight RD pile wall as a trough structure.

EN ISO 14001 Environmental management systems. Requirements with guidance for use

EN ISO 15609-1 Specification and qualification of welding procedures for metallic materials - Welding procedure specification - Part 1: Arc welding

3 Terms and definitions

Anchorage

Anchoring system for a retaining wall, for example anchor plates or anchor walls including the connecting rods (tie rods), screw anchors, ground and rock anchors, driven ground anchors, anchoring piles and anchors with grouted or expanded bodies.

Auxiliary structures

All structures necessary for the proper and safe execution of pile wall and sheet piling work.

Bracing

System of walings and struts to support the structure.

Caterpillar track level

Elevation of bottom of caterpillar tracks of piling equipment.

Combined wall

Retaining wall composed of primary and secondary elements. The primary elements can be steel tubes, beams or box piles. The secondary elements are normally U or Z-shaped steel sheet piles.

Connector

Hot rolled or fabricated device that connects adjacent piles by means of a thumb and finger or similar configuration to make a continuous wall. Connectors perform the same function as interlocks but are fabricated separately and not as an integral part of the pile.

Guide frame

Frame consisting of one or more stiff guide beams, normally of steel or wood, to position and maintain the alignment of piles during pitching and driving.

Interlock connection

Portion of a steel sheet pile that connects adjacent elements by means of a thumb and finger or similar configuration to make a continuous wall.

Pile wall

Screen of pile pipes which forms a continuous wall. Continuity is provided by connectors attached to pile pipes.

Pile wall structure

Structure, consisting of pile pipes, sheet piles, soil and rock anchorages, bracings and walings, which retains ground and water.

Sheet pile wall

Line of sheet piles that forms a continuous wall by threading of the interlocks.

Site inspection

Inspection of the construction site and its surroundings.

Site investigation

Investigations on and near site to verify geotechnical conditions, find out existing structures above and below ground and their foundations and possible driveability tests.

Strut

Long compression member, usually of steel, wood or reinforced concrete, for the support of the pile walls and normally connected to the walings.

Waling

Horizontal beam, usually of steel or reinforced concrete, fixed to the pile wall and connected to the anchorage or struts, in order to distribute the applied anchor or strut forces equally over the pile wall.

4 Information needed for the execution of RD pile walls

4.1 General

The following information shall be made available before commencing installation of the RD pile wall structure:

- location maps of the construction site, including access roads and possible obstacles;
- level and position of fixed reference points at or near the construction site;
- access restrictions concerning equipment and materials;
- location of all services such as electricity, telephone, water and gas supply pipes, and sewers;
- geotechnical data of the construction site;
- composition and stratification of the ground and its variation across the site;
- strength and deformation properties of the soil and rock layers;
- possible presence of stones and boulders in the ground;
- possibility of cohesive soils adhering to the piles when extracted (see 8.11);
- hydrogeological data of the area in which the construction site will be situated;
- specifications, including full details such as pile size, steel grade, protection and preservation systems and also whether any connector fixings are required to ensure transmission of the longitudinal shear forces;
- presence of sensitive buildings and/or installations in the vicinity of the construction site;
- noise and vibration restrictions;
- drilling method and drilling assistance restrictions;
- restrictions regarding the permeability of the retaining wall for water or other fluids;
- various stages of building the wall structure required by the design;
- in the case of waterfront structures; the water levels and their fluctuations (amplitude, frequency and the cause of the fluctuations, e.g. discharge of a barrage, tide, etc.);
- data regarding possible soil contamination;
- list of any identified specific items to be investigated (see 4.2).

4.2 Specific

The following specific information shall be made available before work commences;

- all specific design information which is important to building an RD pile wall;
- restrictions related to the presence, at or near the site, of ground anchors, cathodic protection devices and similar;
- history of the building site: presence of foundation remnants or other artificial elements in the ground.

Information about the following should be made available before work commences:

- special aspects particular to the project, such as corrosion and abrasion problems ;
- comparable experience from work in the neighborhood or from similar work carried out under similar conditions ;
- condition of nearby buildings, structures or installations and the nature and depth of their foundation;
- data about adverse weather conditions, for example, wind conditions and frequency;
- severe frost action in the ground, where this can lead to over-stressing of an wall.

4.3 Execution classes

According to design standard EN 1990 (Eurocode. Basis of structural design) it is mandatory to define a consequences class or a reliability class for all structures designed according to Eurocode design standards, also for retaining walls. Based on the defined class an applicable execution class for steel structures is chosen according to EN 1993-1-1 (Eurocode 3: Design of steel structures. Part 1-1: General rules and rules for buildings). Execution classes are denoted as EXC1 to EXC4, for which requirement strictness increases from EXC1 to EXC3 with EXC4 being based on EXC3 with further project specific requirements.

Permanent structures should be executed in minimum EXC2. If execution class is not specified, EXC2 should be applied for permanent structures and EXC1 for temporary structures.

Requirements according to each execution class are defined in execution standards. For steel structures in retaining walls two different execution standards are followed. EN 12063 (Execution of special geotechnical work. Sheet pile walls, combined pile walls, high modulus walls) is followed for steel piles in retaining walls and EN 1090-2 (Execution of steel structures and aluminium structures. Part 2: Technical requirements for steel structures) is followed for all other steel structures.

Execution standard EN 12063 for sheet pile walls, combined pile walls and high modulus walls is followed in manufacturing and installation of steel pile elements used in RD pile walls. However in EN 12063 the execution classes are considered only in welding requirements for the pile. In case of the RD pile wall, the execution classes are followed on attachment welds, splicing welds and sealing welds of the connectors and splicing welds of the piles.

Execution standard EN 1090-2 for steel structures is followed in execution of other steel structures, for example walings, struts and their connections. EN 1090-2 considers execution classes and gives different requirements for them.

5 Site investigations

The content and scope of the geotechnical site investigation program should be designed to take into account the demands of ground conditions, taking into consideration the environment and trench structures. The geotechnical investigation program must include geotechnical surveys taking into account excavation work risk management, work planning and quality control. Test points should be positioned to correspond as closely as possible to the final location of the excavation structure. Target levels of retaining walls must be determined from research points located on the final wall line.

5.1 Geotechnical investigations

Geotechnical investigations must provide sufficient data on the ground and groundwater conditions at and around the excavation

Table 1. Pile sizes used in RD pile walls

Pile	Diameter [mm]	Weight [kg/m] *								
		Wall thickness [mm]								
		10	12.5	14.2	16	18	20	21	22	23
RD220	219.1	51.6	63.7							
RD270	273.0	64.9	80.3							
RD320	323.9	77.4	96.0							
RD400	406.4	97.8	121.4							
RD500	508.0	122.8	152.7	172.9	194.1					
RD600	610.0	148.0	184.2	208.6	234.4	262.8				
RD700	711.0	172.9	215.3	244.0	274.2	307.6	340.8			
RD800	813.0	198.0	546.8	279.7	314.5	352.9	391.1	410.2	429.2	
RD900	914.0	222.9	277.9	615.1	354.3	397.7	440.9	462.5	484.0	
RD1000	1016.0		309.3	350.8	394.6	443.0	491.3	515.3	539.3	563.2
RD1200	1220.0			422.3	475.1	533.6	591.9	621.0	650.0	679.0

Steel grades S460MH and S550J2H
Steel grades S355J2H, S440J2H and S550J2H

Steel grades S355J2H and S440J2H
Check availability from SSAB sales

site for a proper description of the essential ground properties and a reliable assessment of the characteristic values of the ground parameters to be used in determining earth pressures on the retaining wall. Geotechnical investigations determine the target level of the piles, which enables the order of cut-to-size piles and avoids extra loss of material. If the RD pile wall is extended to the bedrock, the variations in elevation and the quality of the bedrock surface must be determined by percussion drilling.

Basic scope of geotechnical investigations should be at least 1 test point / 10 meters at the wall line. If the RD pile wall is extended to the bedrock, percussion drilling must be used, and boreholes must penetrate at least 3 meters into the bedrock. In challenging projects and soil conditions, drill point frequency should be 1 test point / 3...5 meters.

Extensive geotechnical investigations combined with factory deliveries with specific pile lengths creates the basis for both the structural and financial success of the project without need of changes during installation work.

Any investigations must comply with Section 3 of EN 1997-1 (Eurocode 7: Geotechnical design – Part 1: General rules).

6 Materials and accessories

6.1 Pile pipes

RD pile walls can be made out of different pile sizes ranging from pile RD220 up to RD1200. The piles are delivered in exact pre-defined lengths and, when needed, with welding bevels. Table 1 shows the pile sizes used in RD pile walls.

Large diameter (\geq RD400) steel pipe piles are manufactured by spiral welding and small diameter piles (\leq RD320) by longitudinal welding. For spirally welded piles it is recommended to use element lengths of minimum 6 meters. With shorter element lengths the out-of-roundness of the pile pipe can cause problems in attachment and functioning of drill bits and in splicing of piles by welding.

Steel grades of piles

SSAB steel grades S440J2H, S460MH and S550J2H, manufactured especially for piling, can be used in RD pile walls. For RD pile walls built with RD400 or larger piles, steel grade S355J2H can also be used. Steel grade can have a significant effect on the structural resistance of the pile wall. For instance, by choosing high-strength steel grade S550J2H it is possible in many cases to reduce pile diameter or wall thickness. Table 1 shows the steel grades available for different pile sizes. Table 2 shows the chemical composition and mechanical properties of steel grades.

6.2 Connectors

In RD pile walls, the pile pipes are joined to each other by connectors. Adjacent piles are always locked together with a connector pair, where one connector profile is narrow and the other is wide. The unique SSAB RM/RF connectors shown in Figure 11 are especially developed for the RD pile wall. RM/RF connectors enable use of sealant material inside the female connector to achieve watertight pile wall structure.

With RM/RF connectors and injection channel integrated in RF connector it is also possible to achieve water tightness and rigid connection between piles and bedrock without need for additional injection pipes. RM/RF connectors are available from pile size RD220 to pile size RD1200. Wide or narrow E21 connectors shown in Figure 12 are used to attach a sheet pile wall to an RD pile wall.

Table 2. Standard steel grades for RD pile wall.

Steel grade	Carbon equivalent	Chemical composition, max.				Mechanical properties				
	CEV max [%]	C [%]	Mn [%]	P [%]	S [%]	f_y min [MPa]	f_u [MPa]	A_5 min [%]	Impact strength T [°]	KV min [J]
S355J2H	0.45	0.22	1.6	0.03	0.03	355	470-630	20	-20	27
S440J2H	0.45	0.16	1.6	0.02	0.02	440	490-630	17	-20	27
S460MH	0.46	0.16	1.7	0.035	0.03	460	530-720	17	-20	40
S550J2H	0.47	0.12	1.9	0.02	0.02	550	605-760	14	-20	27

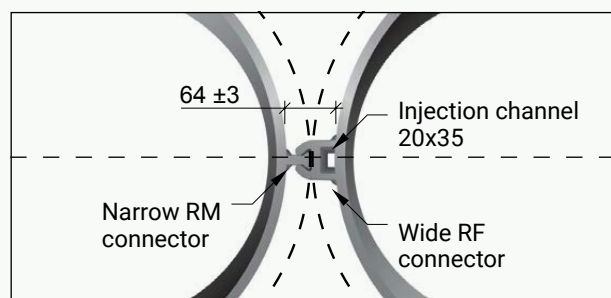

Figure 11. RM/RF connectors

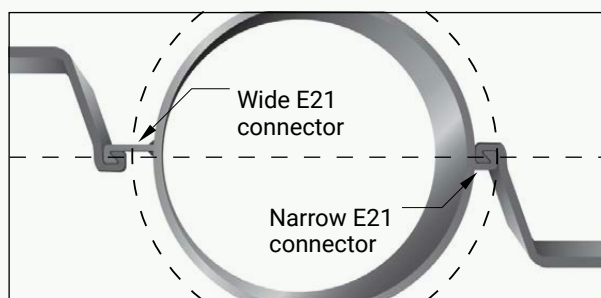

Figure 12. E21 connectors

6.3 Drill bits

RD pile walls are installed by the concentric drilling method using ring bits of a larger diameter than standard bits. The ring bit drills a hole larger than the pile to accommodate also the connectors. Table 3 shows the recommended ring bit diameters for different pile sizes and RM/RF connectors. In soft soil conditions with no stones or friction soil layers in ground, smaller diameter drill bits can also be used.

There are two basic types of ring bits: an integrated ring bit (fixed, locked into the casing shoe, Figure 13a) and a solitary ring bit (loose, not locked into the casing shoe, Figure 13b). Both types can be used for RD pile walls. Alternatively, concentric multi-wing pilot bits (Figure 13c) can be used. The wing bits open when drilling starts and are brought back in when drilling ends so that the entire bit, including wings, is lifted up from pile. A casing shoe will not necessarily be part of the load-bearing structure when a multi-wing pilot is used.

When an integrated or solitary ring bit is used, the ring bit and casing shoe will be part of the load-bearing structure of the pile. Since the ring bit and the casing shoe are used as a load-bearing part, they must be able to withstand the stresses ex-

erted on them. The rock shelf may not provide support to the ring bit if it is not filled with concrete or injection grout.

When drilled piles are long or soil conditions are demanding with boulders or stony soils, casing shoe model has an effect on installation reliability. In such cases it has been found out that only surface hardened flat steel ring attached to inner surface of pile pipe is susceptible to deformations and also damaging during installation.

Multi-wing pilot bits are not recommended in situations where soil contains boulders or the bedrock surface is heavily inclined. If piles are not drilled into the bedrock, closing of the wings after drilling can be difficult or even impossible. In such situations the recess to which the wings are folding in might be filled with soil, also soil below the pilot bit does not offer firm enough base to fold the wings in.

Casing shoes, ring bits and pilots are not part of SSAB's delivery. Subject to order, casing shoes provided by the customer may be welded to the pile pipes at SSAB's premises.



Figure 13. Drilling accessories used in RD pile wall construction (Figure: Robit Oyj)

Table 3. Recommended ring bit diameters for RM/RF connectors

Pile	Pile diameter [mm]	RM/RF Ring bit diameter [mm]
RD220	219.1	273
RD270	273.0	327
RD320	323.9	378
RD400	406.4	460
RD500	508.0	562
RD600	610.0	664
RD700	711.0	765
RD800	831.0	867
RD900	914.0	968
RD1000	1016.0	1070
RD1200	1220.0	1274

6.4 Sealants for connectors

To ensure water tightness of the RD pile wall, the connectors may be fitted with sealants. Water tightness greatly depends on installation circumstances, ground conditions and the sealing materials used. There are several sealing materials and manufacturers available in the market. Some of the sealants can be added to connectors at mill and some can be added at the site. The most suitable sealing material for each specific project needs to be considered separately.

When selecting a sealant material, attention must be paid on project specific environmental requirements. For example specific certificates may be required for materials in contact with drinking water.

The water tightness of RM/RF connectors with some different sealant materials has been tested in laboratory conditions. Table 4 shows the test results for estimated water tightness. The feasibility of the sealant must be estimated separately for each installation site.

Table 4. Water tightness estimate (PU = polyurethane)

Sealant material	Water pressure achieved in test [m]		
	Immediately after installation	1 day after installation	1 month after installation
Plain RM/RF connectors	0	0	0
Bitumen sealat	60*	60*	60*
PU based sealant	0	15*	15*
Tar - Grease mix	0	0	0

*) The value is the maximum possible water pressure achieved with the particular test equipment.

During the water tightness tests, also water flow through the RM/RF connectors without a sealant was measured at different water pressure values. Table 5 shows the estimated results.

Table 5. Water flow through an empty RM/RF connectors at different water pressures

	Water flow through connectors [l/h/m]								
	Water pressure [m]								
	1	2	3	4	5	6	7	8	9
Empty RM/RF connectors	50	100	150	200	250	300	350	400	450

Sealant material effect on friction

The effect of sealant materials on friction between connectors has been defined experimentally. Table 6 shows the estimated friction factors to dynamic and static friction for some sealant materials. For PU based sealant material, the friction factors have been defined both instantly after extrusion and after the sealant has cured due to humidity.

Table 6. Effect of different sealant materials on friction between connectors

Sealant material	Experimentally defined friction factor	
	Static friction	Dynamic friction
Plain RM/RF connectors	0.62	0.50
Bitumen sealant	0.27	0.23
PU based sealant after extrusion	0.31	0.27
PU based sealant after curing	0.26	0.22
Tar - Grease mix	0.40	0.33

6.5 Other materials and accessories

The structural resistance of the RD pile wall in normal situations as well as under fire can be increased by filling the piles with concrete and by using composite effect. Also reinforcement bars can be used to increase the resistance. Material requirements for concrete and reinforcement bars are the same as when using composite effect on SSAB RR and RD piles generally. Design and installation manual for RR and RD piles has more info on the requirements for concrete and reinforcement bars.

An RD pile wall can be supported externally by soil or rock anchors, or by tension rods attached to anchor plates in the same way as other retaining wall structures. RD pile walls exposed to a high fire risk, i.e. in parking facilities can be protected by separate cladding.

7 Design of RD pile wall structures

7.1 General

RD pile walls are designed according to Eurocode design standards, their national annexes and additional national regulations. Main design standard to be followed is EN 1993-5 (Eurocode 3: Design of steel structures – Part 5: Piling). Also the topics given in Chapter 7 of execution standard EN 12063 need to be considered in design.

An RD pile wall is dimensioned as a conventional retaining wall structure. According to EN 1993-5 RD pile wall is so-called high modulus wall. If an RD pile wall is subjected to significant vertical loads, the design and dimensioning practices of pile foundations are applied in the design.

In some projects, design is also possible using national design instructions approved by relevant authorities.

Engineering requires adequate input data about the following:

- soil conditions at the wall and a sufficient distance from it
- groundwater conditions
- effect of the environment and the environmentally-imposed conditions such as foundation types of nearby structures
- size and nature of the structure to be supported
- loading and design life of the RD pile wall.

7.2 Selecting pile size

SSAB's comprehensive range of pile sizes and steel grades enable cost effective design of retaining walls. RD piles can be drilled through all possible soil layers and into the solid bedrock if necessary, while location tolerances and curvatures remain relatively small.

If an RD pile wall is designed according to Eurocode design standards as a retaining structure, the design and dimensioning principles of EN 1997-1, section 9, are observed. If an RD pile wall serves as the foundation of a building, vertical equilibrium must be checked according to the principles of EN 1997-1, section 7. When installed in solid bedrock, the geotechnical resistance of the pile pipe is most often higher than the structural resistance of the wall structure.

The structure of an RD pile wall can be designed as a steel structure or as a composite structure of steel and concrete. If a pile wall is subject to normal force in addition to bending moment, the pile wall must be designed for the combined stresses. Corrosion of steel piles must be considered in the case of long-term and permanent structures if the piles are not corrosion protected.

Tables 7, 8 and 9 show some of the sectional properties and bending moment resistances of RD pile walls excluding corrosion allowance, or with 1.2 mm or 2.0 mm corrosion allowance reduced from the outer surfaces of the steel piles.

Free to use design softwares PileCalc and PileWallCalc are available in the SSAB toolbox to calculate cross-section properties and bending moment resistances for single steel pipe piles or for pile wall structures. In both programs the pile structure can be a steel structure, a composite structure or a reinforced

composite structure. Both programs are web-based and they are available through www.ssab.com/infra.

The SSAB toolbox also contains Tekla Structures components for easy design and 3D modeling of RD pile walls, including allowable design tolerances and assembly lists.

The sizes of tolerances transverse to the wall line are affected mostly by shifts in position during installation. These shifts can be limited by using a sufficiently sturdy guide frame with respect to pile sizes through which the piles are installed.

Both material tolerances and installation tolerances must be considered in design. In design and implementation of wall lines, tolerances must be taken into account especially if the wall incorporates frame columns.

In unrestricted installation space, the smallest recommended pile size is RD270. With smaller pile diameters, the drilling hole oversize required by the connectors increases significantly in relation to the drill hole diameter of the pile itself. The additional stresses caused for the drill bits and hammers must be taken into account in installation.

In cramped or low installation spaces, such as basements or spaces underneath bridges or fixed roofs, the applicable drilling equipment usually limits the usable pile sizes and element lengths. With small size drilling equipment, the maximum pile size is usually RD220 and the maximum element length 2 meters. The handling of pile elements and drill string in cramped spaces is most often done manually. In such cases the weight of the lifted items usually limits the possible sizes and lengths.

With piles RD600 or larger, the recommended pile wall thickness is 12.5 mm. In easy drilling conditions, for example, with low drilling depth in clay or sandy soils, the applied wall thickness may be smaller.

RD pile wall stiffness in bedrock contact

The stiffness of a pile drilled into the bedrock depends on the applied embedment length, strength of the bedrock and deterioration of the rock surface. A moment rigid connection requires grouting of the annulus between pile and bedrock.

Piles extended into the bedrock should be drilled at least 500 mm into it, irrespective of the working principle of the wall. It is recommended that piles transmitting vertical loads and piles whose lower ends are subject to significant moment loads and/or shear forces should have an embedment length of at least 4 times the pile diameter.

Table 7. Sectional properties and bending moment resistances of RD pile walls excluding corrosion allowance.

Pile				Sectional properties and bending moment resistances of RD pile walls, with 0.0 mm corrosion allowance									
RD pile wall	<i>d</i> [mm]	<i>t</i> [mm]	<i>G</i> * [kg/m]	<i>G</i> [kg/m ²]	<i>b</i> [mm]	<i>W_{el}</i> [cm ³ /m]	<i>W_{pl}</i> [cm ³ /m]	<i>EI</i> [kNm ² /m]	S355J2H <i>M_{Rd}</i> [kNm/m]	S440J2H <i>M_{Rd}</i> [kNm/m]	S460MH <i>M_{Rd}</i> [kNm/m]	S550J2H <i>M_{Rd}</i> [kNm/m]	
RD220	219.1	10.0	65.7	232.0	283	1 160	1 546	26 693	-	-	711 [534]**	850 [638]**	
		12.5	77.8	274.8	283	1 401	1 887	32 228	-	-	868 [644]**	1038 [770]**	
RD270	273.0	10.0	79.0	234.3	337	1 555	2 053	44 580	729 [552]**	-	945 [715]**	1129 [855]**	
		12.5	94.4	280.1	337	1 891	2 519	54 198	894 [671]**	-	1159 [870]**	1385 [1040]**	
RD320	323.9	10.0	91.5	235.9	388	1 935	2 541	65 822	902 [687]**	-	1169 [890]**	1 064	
		12.5	110.1	283.8	388	2 363	3 127	80 376	1110 [839]**	-	1438 [1087]**	1720 [1300]**	
RD400	406.4	10.0	111.9	237.8	470	2 561	3 341	109 267	1186 [909]**	1 127	1 178	1274 [1408]**	
		12.5	135.5	288.1	470	3 142	4 124	134 065	1464 [1115]**	1815 [1382]**	1897 [1445]**	1 728	
RD500	508.0	10.0	136.9	239.4	572	3 340	4 336	178 134	1 186	1329 [1469]**	1388 [1536]**	1653 [1837]**	
		12.5	166.8	291.7	572	4 113	5 367	219 382	1905 [1460]**	1 810	1 892	2049 [2262]**	
		14.2	187.0	327.0	572	4 625	6 055	246 708	2150 [1642]**	2664 [2035]**	2 128	2 544	
		16.0	208.2	364.0	572	5 156	6 773	275 016	2405 [1830]**	2980 [2269]**	3116 [2372]**	2 836	
RD600	610.0	10.0	162.1	240.5	674	4 127	5 342	264 359	1326 [1465]**	1637 [1816]**	1710 [1899]**	2032 [2270]**	
		12.5	198.3	294.2	674	5 096	6 622	326 387	1 809	2033 [2242]**	2124 [2344]**	2533 [2803]**	
		14.2	222.7	330.5	674	5 740	7 480	367 668	2655 [2038]**	2 526	2 641	2861 [3157]**	
		16.0	248.5	368.7	674	6 411	8 378	410 595	2974 [2276]**	2 821	2 949	3 526	
		18.0	276.9	410.8	674	7 141	9 362	457 360	3324 [2535]**	4119 [3142]**	4307 [3285]**	3 927	
RD700	711.0	10.0	187.0	241.3	775	4 911	6 341	366 623	1576 [1743]**	1943 [2161]**	2028 [2259]**	2407 [2701]**	
		12.5	229.4	296.0	775	6 074	7 870	453 446	2 156	2420 [2673]**	2528 [2794]**	3013 [3341]**	
		14.2	258.1	333.1	775	6 850	8 897	511 412	2 432	2734 [3014]**	2858 [3151]**	3410 [3768]**	
		16.0	288.3	372.0	775	7 660	9 974	571 850	3541 [2719]**	3 370	3 524	3821 [4213]**	
		18.0	321.7	415.1	775	8 544	11 157	637 885	3961 [3033]**	3 760	3 930	4267 [4699]**	
		20.0	354.9	458.0	775	9 413	12 326	702 757	4376 [3342]**	5423 [4142]**	5670 [4330]**	5 177	
RD800	813.0	10.0	212.1	241.9	877	5 704	7 353	486 960	1828 [2025]**	2251 [2510]**	2350 [2624]**	2784 [3137]**	
		12.5	260.9	297.5	877	7 065	9 134	603 086	2274 [2508]**	2811 [3109]**	2937 [3250]**	3497 [3886]**	
		14.2	293.8	335.0	877	7 975	10 333	680 800	2 831	3181 [3509]**	3324 [3669]**	3965 [4386]**	
		16.0	328.6	374.7	877	8 926	11 590	761 990	3 169	3565 [3928]**	3726 [4106]**	4449 [4909]**	
		18.0	367.0	418.5	877	9 968	12 974	850 895	4606 [3539]**	4 386	4 585	4975 [5482]**	
		20.0	405.2	462.1	877	10 993	14 344	938 437	5092 [3903]**	4 837	5 057	5491 [6046]**	
		23.0	462.2	527.0	877	12 502	16 372	1 067 227	5812 [4438]**	7204 [5501]**	7531 [5751]**	6 876	
RD900	914.0	10.0	237.0	242.4	978	6 492	8 356	623 015	2077 [2305]**	2557 [2856]**	2668 [2986]**	3156 [3570]**	
		12.5	292.0	298.6	978	8 048	10 388	772 380	2589 [2857]**	3199 [3541]**	3342 [3702]**	3976 [4426]**	
		14.2	329.2	336.6	978	9 092	11 756	872 519	2929 [3228]**	3624 [4000]**	3787 [4182]**	4514 [5000]**	
		16.0	368.4	376.7	978	10 183	13 194	977 298	3 615	4066 [4481]**	4249 [4684]**	5071 [5601]**	
		18.0	411.8	421.1	978	11 381	14 778	1 092 225	4 040	4548 [5008]**	4754 [5235]**	5677 [6259]**	
		20.0	455.0	465.3	978	12 562	16 347	1 205 592	5803 [4460]**	5 527	5 779	6273 [6909]**	
		23.0	519.5	531.2	978	14 304	18 674	1 372 747	6629 [5078]**	6 294	6 580	7148 [7867]**	
		12.5	323.4	299.5	1080	9 043	11 656	964 684	2907 [3210]**	3590 [3979]**	3749 [4160]**	4457 [4974]**	
RD1000	1016.0	14.2	364.9	337.9	1080	10 221	13 196	1 090 371	3292 [3628]**	4071 [4497]**	4253 [4702]**	5067 [5622]**	
		16.0	408.7	378.4	1080	11 455	14 816	1 222 043	3693 [4067]**	4571 [5040]**	4777 [5269]**	5699 [6300]**	
		18.0	457.1	423.3	1080	12 811	16 602	1 366 661	4 548	5118 [5637]**	5349 [5893]**	6387 [7046]**	
		20.0	505.4	467.9	1080	14 150	18 373	1 509 519	5 023	5656 [6226]**	5912 [6509]**	7063 [7782]**	
		23.0	577.3	534.6	1080	16 128	21 003	1 720 537	7456 [5725]**	7 096	7 419	8057 [8870]**	
RD1200	1220.0	14.2	436.4	339.8	1284	12 484	16 080	1 599 148	4014 [4432]**	4957 [5493]**	5177 [5742]**	6153 [6866]**	
		16.0	489.2	381.0	1284	14 004	18 065	1 793 867	4510 [4971]**	5577 [6162]**	5827 [6442]**	6940 [7702]**	
		18.0	547.7	426.5	1284	15 676	20 256	2 008 156	5054 [5565]**	6255 [6898]**	6537 [7211]**	7797 [8622]**	
		20.0	606.0	471.9	1284	17 332	22 432	2 220 284	5590 [6153]**	6923 [7626]**	7236 [7973]**	8638 [9533]**	
		23.0	693.1	539.8	1284	19 785	25 669	2 534 456	7 024	7908 [8705]**	8267 [9101]**	9876 [10882]**	

*) The weight of pile pipe in column *G* [kg/m] includes also the weight of the RM/RF connectors
 **) Cross-section class 1 or 2, the design value of resistance is given as plastic resistance [in brackets the value is given as elastic resistance]
 ***) Cross-section class 4, the local buckling is considered in the design value of resistance [in brackets the value is given as elastic resistance]
 For piles belonging to cross-section class 3, the design value of resistance is given as elastic resistance.

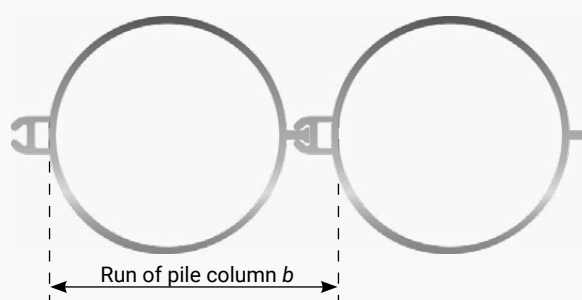

Table 8. Sectional properties and bending moment resistances of RD pile walls with 1.2 mm corrosion allowance.

Pile		Sectional properties and bending moment resistances of RD pile walls, with 1.2 mm corrosion allowance										
RD pile wall	<i>d</i> [mm]	<i>t</i> [mm]	<i>G</i> * [kg/m]	<i>G</i> [kg/m ²]	<i>b</i> [mm]	<i>W_{el}</i> [cm ² /m]	<i>W_{pl}</i> [cm ² /m]	<i>EI</i> [kNm ² /m]	S355J2H <i>M_{Rd}</i> [kNm/m]	S440J2H <i>M_{Rd}</i> [kNm/m]	S460MH <i>M_{Rd}</i> [kNm/m]	S550J2H <i>M_{Rd}</i> [kNm/m]
RD220	219.1	10.0	65.7	232.0	283	1 014	1 344	23 076	-	-	618 [467]**	739 [558]**
		12.5	77.8	274.8	283	1 257	1 686	28 611	-	-	775 [578]**	927 [692]**
RD270	273.0	10.0	79.0	234.3	337	1 361	1 790	38 684	636 [483]**	-	824 [626]**	749
		12.5	94.4	280.1	337	1 700	2 256	48 301	801 [603]**	-	1038 [782]**	1241 [935]**
RD320	323.9	10.0	91.5	235.9	388	1 696	2 219	57 249	788 [602]**	-	780	933
		12.5	110.1	283.8	388	2 127	2 804	71 802	996 [755]**	-	1290 [978]**	1542 [1170]**
RD400	406.4	10.0	111.9	237.8	470	2 246	2 922	95 271	1037 [797]**	988	1 033	1114 [1235]**
		12.5	135.5	288.1	470	2 830	3 706	120 069	1315 [1005]**	1630 [1245]**	1705 [1302]**	1 557
RD500	508.0	10.0	136.9	239.4	572	2 931	3 797	155 613	1 041	1162 [1290]**	1214 [1348]**	1443 [1612]**
		12.5	166.8	291.7	572	3 708	4 828	196 861	1714 [1316]**	1 632	1 706	1844 [2040]**
		14.2	187.0	327.0	572	4 223	5 516	224 188	1958 [1499]**	1 858	1 943	2106 [2323]**
		16.0	208.2	364.0	572	4 756	6 235	252 495	2213 [1688]**	2743 [2093]**	2868 [2188]**	2 616
RD600	610.0	10.0	162.1	240.5	674	3 624	4 682	231 228	1161 [1287]**	1431 [1595]**	1494 [1667]**	1771 [1993]**
		12.5	198.3	294.2	674	4 597	5 962	293 257	1 632	1831 [2023]**	1913 [2114]**	2279 [2528]**
		14.2	222.7	330.5	674	5 244	6 820	334 538	1 862	2 307	2188 [2412]**	2610 [2884]**
		16.0	248.5	368.7	674	5 917	7 718	377 465	2740 [2100]**	2 603	2 722	2952 [3254]**
		18.0	276.9	410.8	674	6 650	8 703	424 230	3089 [2361]**	3829 [2926]**	3 059	3 657
RD700	711.0	10.0	187.0	241.3	775	4 314	5 561	320 960	1379 [1531]**	1697 [1898]**	1770 [1984]**	2094 [2373]**
		12.5	229.4	296.0	775	5 481	7 090	407 783	1763 [1946]**	2179 [2412]**	2276 [2521]**	2709 [3014]**
		14.2	258.1	333.1	775	6 260	8 117	465 748	2 222	2496 [2754]**	2609 [2880]**	3111 [3443]**
		16.0	288.3	372.0	775	7 072	9 194	526 186	2 511	3 112	2952 [3253]**	3524 [3890]**
		18.0	321.7	415.1	775	7 960	10 377	592 222	3684 [2826]**	3 502	3 661	3973 [4378]**
		20.0	354.9	458.0	775	8 832	11 545	657 094	4099 [3135]**	3 886	4 063	4 857
RD800	813.0	10.0	212.1	241.9	877	5 012	6 451	426 592	1599 [1779]**	1965 [2205]**	2049 [2306]**	2419 [2757]**
		12.5	260.9	297.5	877	6 376	8 232	542 718	2050 [2264]**	2531 [2806]**	2644 [2933]**	3143 [3507]**
		14.2	293.8	335.0	877	7 290	9 431	620 431	2348 [2588]**	2904 [3207]**	3034 [3353]**	3616 [4009]**
		16.0	328.6	374.7	877	8 243	10 689	701 622	2 926	3291 [3627]**	3439 [3792]**	4103 [4534]**
		18.0	367.0	418.5	877	9 288	12 072	790 527	3 297	3711 [4087]**	3879 [4272]**	4633 [5108]**
		20.0	405.2	462.1	877	10 317	13 442	878 069	4772 [3662]**	4 539	4 746	5151 [5674]**
		23.0	462.2	527.0	877	11 830	15 470	1 006 858	5492 [4200]**	6807 [5205]**	5 442	6 506
RD900	914.0	10.0	237.0	242.4	978	5 705	7 334	546 058	1817 [2025]**	2229 [2510]**	2324 [2624]**	2738 [3138]**
		12.5	292.0	298.6	978	7 265	9 366	695 423	2334 [2579]**	2880 [3197]**	3007 [3342]**	3572 [3996]**
		14.2	329.2	336.6	978	8 312	10 734	795 562	2676 [2951]**	3309 [3657]**	3456 [3823]**	4116 [4571]**
		16.0	368.4	376.7	978	9 406	12 172	900 341	3032 [3339]**	3753 [4139]**	3921 [4327]**	4677 [5173]**
		18.0	411.8	421.1	978	10 607	13 755	1 015 268	3 765	4237 [4667]**	4428 [4879]**	5287 [5834]**
		20.0	455.0	465.3	978	11 791	15 325	1 128 634	4 186	4713 [5188]**	4927 [5424]**	5885 [6485]**
		23.0	519.5	531.2	978	13 538	17 652	1 295 790	6266 [4806]**	5 957	6 227	6763 [7446]**
RD1000	1016.0	10.0	262.2	242.8	1080	6 406	8 227	681 727	2036 [2274]**	2494 [2818]**	2599 [2947]**	3055 [3523]**
		12.5	323.4	299.5	1080	8 164	10 512	868 925	2620 [2898]**	3231 [3592]**	3373 [3756]**	4002 [4490]**
		14.2	364.9	337.9	1080	9 345	12 052	994 612	3007 [3318]**	3716 [4112]**	3882 [4299]**	4619 [5140]**
		16.0	408.7	378.4	1080	10 583	13 672	1 126 284	3410 [3757]**	4219 [4656]**	4409 [4868]**	5256 [5820]**
		18.0	457.1	423.3	1080	11 941	15 458	1 270 902	3851 [4239]**	4768 [5254]**	4983 [5493]**	5948 [6568]**
		20.0	505.4	467.9	1080	13 284	17 229	1 413 760	4 716	5308 [5845]**	5549 [6111]**	6627 [7306]**
		23.0	577.3	534.6	1080	15 266	19 859	1 624 778	5 420	6 717	6381 [7023]**	7625 [8397]**
RD1200	1220.0	10.0	312.5	243.4	1284	7 809	10 015	998 351	2461 [2772]**	2997 [3436]**	3117 [3592]**	3633 [4295]**
		12.5	386.3	300.9	1284	9 966	12 807	1 274 080	3186 [3538]**	3918 [4385]**	4087 [4584]**	4827 [5481]**
		14.2	436.4	339.8	1284	11 417	14 692	1 459 609	3666 [4053]**	4521 [5023]**	4720 [5252]**	5600 [6279]**
		16.0	489.2	381.0	1284	12 940	16 677	1 654 329	4164 [4594]**	5146 [5694]**	5375 [5952]**	6396 [7117]**
		18.0	547.7	426.5	1284	14 616	18 867	1 868 618	4710 [5189]**	5827 [6431]**	6089 [6723]**	7258 [8039]**
		20.0	606.0	471.9	1284	16 275	21 044	2 080 746	5248 [5778]**	6498 [7161]**	6791 [7487]**	8104 [8951]**
		23.0	693.1	539.8	1284	18 733	24 280	2 394 918	6 650	7486 [8242]**	7825 [8617]**	9346 [10303]**

*) The weight of pile pipe in column G [kg/m] includes also the weight of the RM/RF connectors

**) Cross-section class 1 or 2, the design value of resistance is given as plastic resistance [in brackets the value is given as elastic resistance]

***) Cross-section class 4, the local buckling is considered in the design value of resistance [in brackets the value is given as elastic resistance]

For piles belonging to cross-section class 3, the design value of resistance is given as elastic resistance.

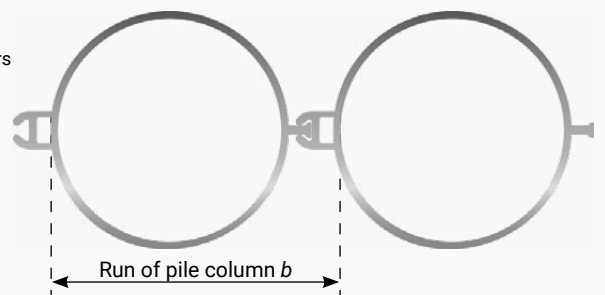

Table 9. Sectional properties and bending moment resistances of RD pile walls with 2.0 mm corrosion allowance.

Pile			Sectional properties and bending moment resistances of RD pile walls, with 1.2 mm corrosion allowance									
RD pile wall	d [mm]	t [mm]	G* [kg/m]	G [kg/m ²]	b [mm]	W _{el} [cm ³ /m]	W _{pl} [cm ³ /m]	EI [kNm ² /m]	S355J2H M _{Rd} [kNm/m]	S440J2H M _{Rd} [kNm/m]	S460MH M _{Rd} [kNm/m]	S550J2H M _{Rd} [kNm/m]
RD220	219.1	10.0	65.7	232.0	283	918	1 213	20 731	-	-	558 [422]**	667 [505]**
		12.5	77.8	274.8	283	1 163	1 554	26 266	-	-	715 [535]**	855 [640]**
RD270	273.0	10.0	79.0	234.3	337	1 233	1 618	34 839	574 [438]**	-	744 [567]**	678
		12.5	94.4	280.1	337	1 574	2 083	44 457	740 [559]**	-	958 [724]**	1 146 [866]**
RD320	323.9	10.0	91.5	235.9	388	1 537	2 007	51 639	712 [546]**	-	707	765 [846]**
		12.5	110.1	283.8	388	1 971	2 592	66 193	920 [700]**	-	1 192 [906]**	1 084
RD400	406.4	10.0	111.9	237.8	470	2 037	2 646	86 078	723	810 [896]**	846 [937]**	1 008 [1 120]**
		12.5	135.5	288.1	470	2 624	3 429	110 876	1 217 [932]**	1 155	1 207	1 443
RD500	508.0	10.0	136.9	239.4	572	2 660	3 441	140 777	853 [944]**	1 051 [1 170]**	1 097 [1 224]**	1 302 [1 463]**
		12.5	166.8	291.7	572	3 440	4 471	182 025	1 221	1 513	1 433 [1 582]**	1 708 [1 892]**
		14.2	187.0	327.0	572	3 956	5 160	209 351	1 832 [1 404]**	1 741	1 820	1 971 [2 176]**
		16.0	208.2	364.0	572	4 491	5 878	237 659	2 087 [1 594]**	2 586 [1 976]**	2 066	2 470
RD600	610.0	10.0	162.1	240.5	674	3 290	4 245	209 358	1 051 [1 168]**	1 293 [1 448]**	1 349 [1 514]**	1 596 [1 810]**
		12.5	198.3	294.2	674	4 265	5 525	271 387	1 514	1 696 [1 877]**	1 772 [1 962]**	2 109 [2 346]**
		14.2	222.7	330.5	674	4 914	6 383	312 668	1 744	1 960 [2 162]**	2 048 [2 260]**	2 443 [2 703]**
		16.0	248.5	368.7	674	5 588	7 281	355 595	2 585 [1 984]**	2 459	2 571	2 786 [3 074]**
		18.0	276.9	410.8	674	6 323	8 266	402 360	2 934 [2 245]**	2 782	2 909	3 478
RD700	711.0	10.0	187.0	241.3	775	3 917	5 044	290 774	1 248 [1 391]**	1 532 [1 723]**	1 597 [1 802]**	1 884 [2 154]**
		12.5	229.4	296.0	775	5 087	6 573	377 597	1 635 [1 806]**	2 019 [2 238]**	2 108 [2 340]**	2 506 [2 798]**
		14.2	258.1	333.1	775	5 867	7 600	435 563	2 083	2 338 [2 582]**	2 443 [2 699]**	2 911 [3 227]**
		16.0	288.3	372.0	775	6 681	8 677	496 001	2 372	2 667 [2 940]**	2 788 [3 073]**	3 327 [3 675]**
		18.0	321.7	415.1	775	7 571	9 859	562 036	3 500 [2 688]**	3 331	3 483	3 777 [4 164]**
		20.0	354.9	458.0	775	8 445	11 028	626 908	3 915 [2 998]**	3 716	3 885	4 218 [4 645]**
RD800	813.0	10.0	212.1	241.9	877	4 552	5 853	386 643	1 446 [1 616]**	1 772 [2 003]**	1 847 [2 094]**	2 173 [2 503]**
		12.5	260.9	297.5	877	5 919	7 634	502 769	1 900 [2 101]**	2 344 [2 604]**	2 448 [2 723]**	2 906 [3 255]**
		14.2	293.8	335.0	877	6 834	8 833	580 483	2 200 [2 426]**	2 720 [3 007]**	2 841 [3 143]**	3 383 [3 758]**
		16.0	328.6	374.7	877	7 789	10 090	661 673	2 765	3 108 [3 427]**	3 247 [3 583]**	3 873 [4 284]**
		18.0	367.0	418.5	877	8 836	11 474	750 578	3 137	3 530 [3 888]**	3 689 [4 065]**	4 405 [4 860]**
		20.0	405.2	462.1	877	9 867	12 844	838 120	4 560 [3 503]**	4 341	4 539	4 925 [5 427]**
RD900	914.0	10.0	237.0	242.4	978	5 181	6 655	495 090	1 642 [1 839]**	2 009 [2 280]**	2 093 [2 383]**	2 457 [2 850]**
		12.5	292.0	298.6	978	6 745	8 687	644 455	2 163 [2 394]**	2 667 [2 968]**	2 784 [3 103]**	3 301 [3 710]**
		14.2	329.2	336.6	978	7 793	10 056	744 593	2 507 [2 766]**	3 098 [3 429]**	3 236 [3 585]**	3 850 [4 286]**
		16.0	368.4	376.7	978	8 889	11 493	849 373	2 864 [3 156]**	3 544 [3 911]**	3 703 [4 089]**	4 415 [4 889]**
		18.0	411.8	421.1	978	10 092	13 077	964 300	3 583	4 030 [4 441]**	4 212 [4 642]**	5 027 [5 551]**
		20.0	455.0	465.3	978	11 279	14 646	1 077 666	4 004	4 507 [4 963]**	4 711 [5 188]**	5 627 [6 203]**
		23.0	519.5	531.2	978	13 028	16 973	1 244 822	6 025 [4 625]**	5 732	5 993	6 508 [7 165]**
RD1000	1016.0	10.0	262.2	242.8	1080	5 818	7 467	618 264	1 840 [2 066]**	2 246 [2 560]**	2 338 [2 676]**	2 736 [3 200]**
		12.5	323.4	299.5	1080	7 580	9 752	805 462	2 429 [2 691]**	2 991 [3 335]**	3 121 [3 487]**	3 696 [4 169]**
		14.2	364.9	337.9	1080	8 763	11 292	931 149	2 817 [3 111]**	3 479 [3 856]**	3 634 [4 031]**	4 319 [4 820]**
		16.0	408.7	378.4	1080	10 002	12 912	1 062 822	3 222 [3 551]**	3 985 [4 401]**	4 163 [4 601]**	4 960 [5 501]**
		18.0	457.1	423.3	1080	11 363	14 698	1 207 440	3 664 [4 034]**	4 535 [5 000]**	4 740 [5 227]**	5 655 [6 250]**
		20.0	505.4	467.9	1080	12 707	16 469	1 350 298	4 511	5 077 [5 591]**	5 307 [5 845]**	6 337 [6 989]**
		23.0	577.3	534.6	1080	14 693	19 099	1 561 315	5 216	5 874 [6 465]**	6 141 [6 759]**	7 337 [8 081]**
RD1200	1220.0	10.0	312.5	243.4	1284	7 094	9 092	905 783	2 218 [2 518]**	2 688 [3 121]**	2 793 [3 263]**	3 234 [3 902]**
		12.5	386.3	300.9	1284	9 254	11 884	1 181 512	2 951 [3 285]**	3 622 [4 072]**	3 776 [4 257]**	4 448 [5 090]**
		14.2	436.4	339.8	1284	10 707	13 770	1 367 041	3 433 [3 801]**	4 230 [4 711]**	4 415 [4 925]**	5 230 [5 889]**
		16.0	489.2	381.0	1284	12 232	15 754	1 561 761	3 934 [4 342]**	4 858 [5 382]**	5 074 [5 627]**	6 031 [6 728]**
		18.0	547.7	426.5	1284	13 910	17 945	1 776 050	4 481 [4 938]**	5 542 [6 120]**	5 790 [6 399]**	6 899 [7 651]**
		20.0	606.0	471.9	1284	15 572	20 121	1 988 177	5 020 [5 528]**	6 214 [6 851]**	6 494 [7 163]**	7 747 [8 564]**
		23.0	693.1	539.8	1284	18 032	23 358	2 302 350	6 401	7 205 [7 934]**	7 531 [8 295]**	8 994 [9 918]**

*) The weight of pile pipe in column G [kg/m] includes also the weight of the RM/RF connectors

***) Cross-section class 1 or 2, the design value of resistance is given as plastic resistance [in brackets the value is given as elastic resistance]

****) Cross-section class 4, the local buckling is considered in the design value of resistance [in brackets the value is given as elastic resistance]

For piles belonging to cross-section class 3, the design value of resistance is given as elastic resistance.

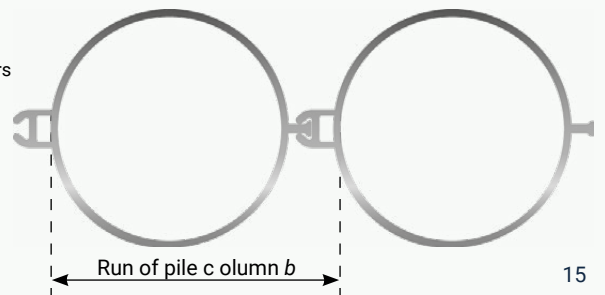

Contact between an RD pile wall and bedrock can be assumed to be rigid if the embedment length of the piles is at least $4 \cdot d$ in the solid un-weathered bedrock, and by grouting the annulus between pile and the rock with grouting concrete C20/25. Deeper embedment length will not further increase the rigidity of the contact. However, a lower drilling depth quickly reduces the rigidity, this also applies if the annulus is not grouted.

Figure 14 shows the indicative maximum stiffness S_j (MNm/rad*m) of the contact for RD220/12.5...RD1200/12.5 RD pile walls using an embedment length of $4 \cdot d$ and C20/25 concrete grouting. In addition Figure 14 shows joint stiffness if the drilling depth is reduced to $3 \cdot d$. Joint stiffness is calculated for the bending moment equaling the elastic bending resistance of the pile pipe.

Figure 15 shows RD pile wall stiffness for non-grouted drilling holes. The applied bending moment was 0.05-elastic bending resistance of the pile pipe. The stiffness of the non-grouted RD pile wall was less than 3 % of a grouted wall in all cases.

The drill rig operator often interprets the bedrock as starting at the level where the pile first contacts the rock surface. However, the bedrock surface is in most cases uneven. Beside above, it can be assumed that grouting of the lowest $1 \cdot d$ in the annulus between pile and the bedrock is not 100 % successful. For these reasons, when estimating the rotational stiffness of the RD pile wall, the effective drilling depth is assumed to be somewhat shorter than the designed embedment length. With grouted piles the actual realized drilling depth is decreased by $2 \cdot d$ and with non-grouted by $1 \cdot d$.

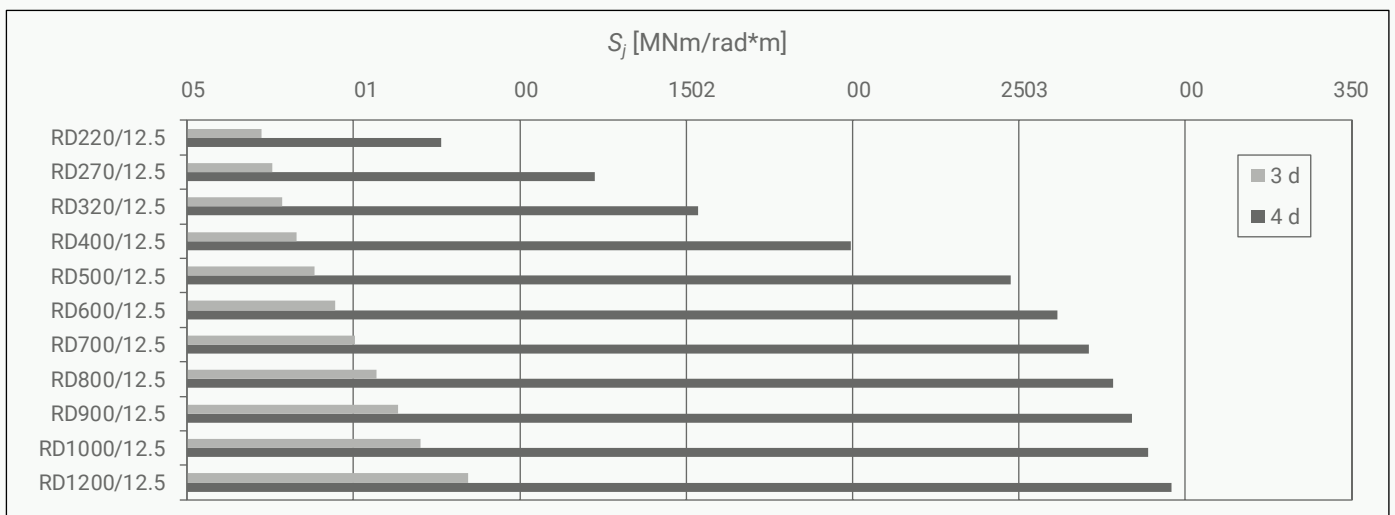

Figure 14. Stiffness of RD pile wall. Pile sizes RD220/12.5 ... 1200/12.5, RM/RF connectors. Nominal strength of concrete grouting C20/25.

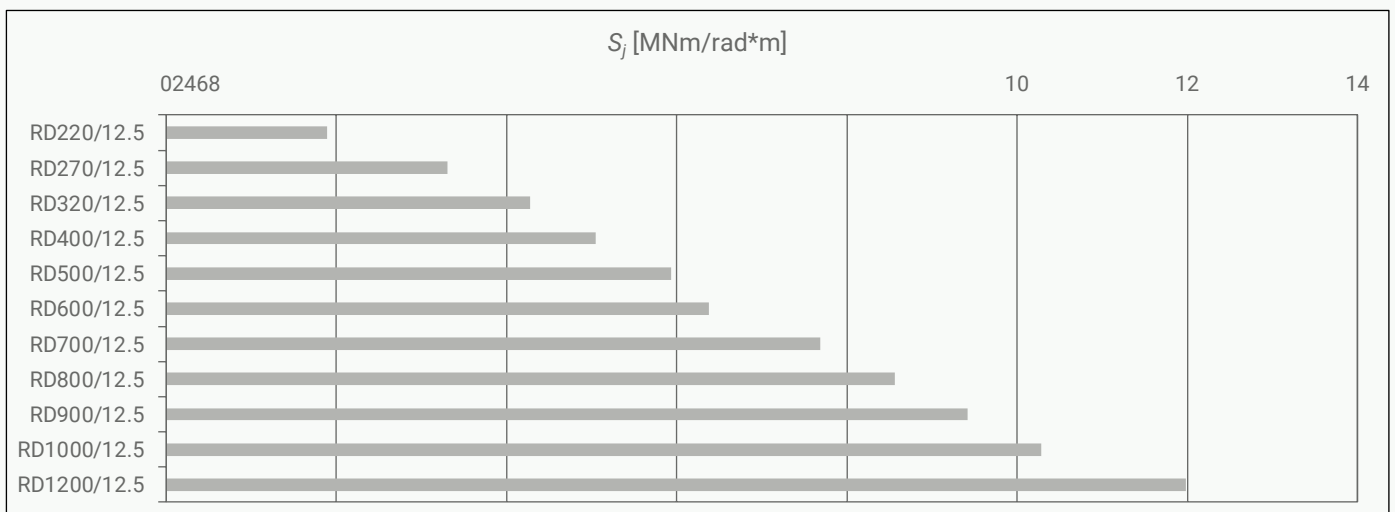

Figure 15. Stiffness of non-grouted RD pile wall. Pile sizes RD220/12.5 ... 1200/12.5, RM/RF connectors. Embedment length $3 \cdot d$ into integral bedrock.

7.3 Connector selection

The necessary angle changes in the RD pile wall line are effected by welding the connectors at the desired angle, Figure 16. Connectors welded on opposite sides of a pile in line with each other allow only small angular deviations, at maximum $\pm 5^\circ$ from the straight wall line, Figure 17. Larger angular deviations must be implemented by welding connectors at the desired angle.

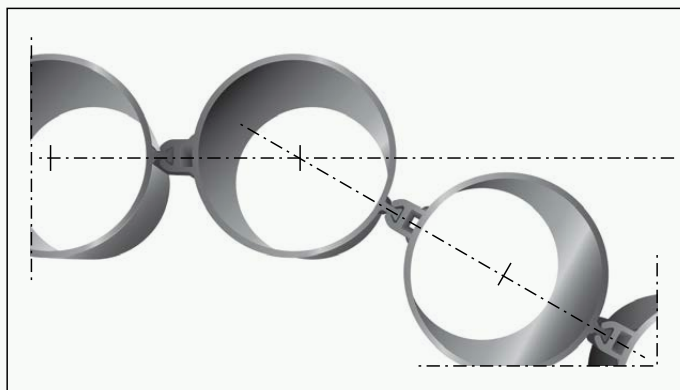

Figure 16. Large angle change in RD pile wall line implemented by welding the connectors at the desired angle.

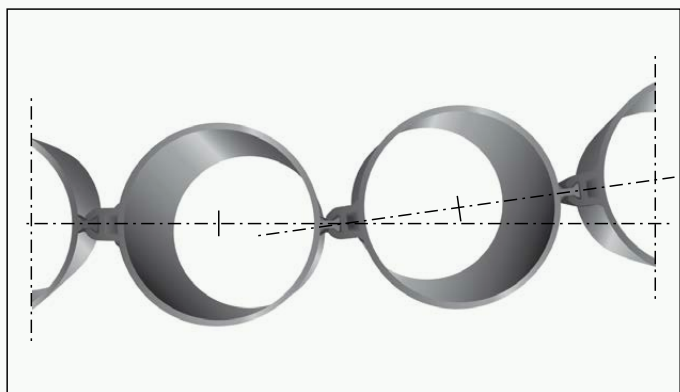

Figure 17. Small angle change in RD pile wall line implemented by the tolerances of the connectors.

Table 7 shows the theoretical run of the pile wall. The actual run of the wall, however, varies slightly due to pile deformation during installation, the out-of-roundness of pile pipes and the play of connectors. The average width of a pair of jointed RM/RF connectors is 64 mm and play about ± 3 mm. According to standard EN 10219, the out-of-roundness tolerance of a structural pipe is $\pm 2\%$ of its outside diameter. Subject to order, the out-of-roundness tolerance of spirally welded piles (\geq RD400) with connectors may be smaller.

Structural resistance of connectors

When installing RD pile walls, there may be significant tensile and compressive forces acting along the axis of connectors, as well as shear forces in the transverse direction. These installation loads are difficult to predict. RM/RF connectors have proven in various different installation conditions and different complexities of the structures to have enough resistance for the installation loads as long as sufficient attention is paid and the installation is done according to the instructions. Some other connector types cannot transport for example any compressive forces due to structural features, unlike the RM/RF connectors, which have an excellent compression resistance.

Table 10 shows the installation resistances of E21 and RM/RF connector types. The given structural resistances are characteristic values determined from the full-scale laboratory tests according to EN 1990, Annex D.

Table 10. Structural resistances of E21 and RM/RF connectors during installation.

Connector	Axial tensile resistance T_d [kN/m]	Axial compression resistance C_d [kN/m]	Shear resistance perpendicular to connector cross-section $V_{y,d}$ [kN/m]
E21	1202	-	374
RM/RF	1702	4260	790

RD pile wall can be designed so that connectors transport long-term loads also in the completed structure. In long-term resistances the effect of corrosion on connectors must be taken into consideration. Table 11 gives the relative reductions to resistance values given in Table 10 due to corrosion reductions of 1.2 mm and 2.0 mm. Corrosion reduction is made from all soil facing surfaces of the connectors excluding the contact surface between the male and female sections. However, it should be noted that since the connectors are at the neutral axis of the pile wall, their influence on the bending moment resistance of the wall is minimal.

Table 11. Relative reductions to resistances of RM/RF connectors in long-term loadings due to corrosion.

Corrosion reduction on the outer surface of the connectors	Reduction in axial tensile resistance [%]	Reduction in axial compression resistance [%]
1.2 mm	5	20
2.0 mm	20	30

7.4 Water tightness and groundwater management

The water tightness of an RD pile wall can be sufficient in some conditions without any special measures. The water tightness of the wall is greatly affected by the soil properties. In low water permeable soils (fine-grained soils) and moderate differential water pressure across the wall ($< 50\text{--}80$ kPa), the amount of water penetrating the connectors is negligible. With increasing differential water pressure and highly water-permeable soils, the probability of leaks through the connectors increases. Due to the installation method, no significant stresses are exerted on the connectors during installation and no leakage points form in them due to deformations.

The water tightness of an RD pile wall can be improved by using bitumen based sealing agent applied hot on the RF connector at SSAB

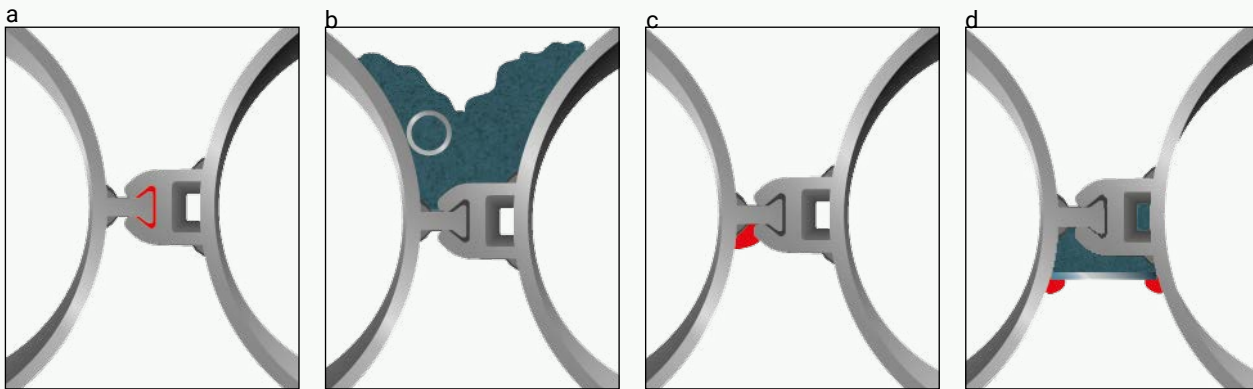

Figure 18. Improving the water tightness of an RD pile wall by applying sealing agents in the connector (Fig. a), by grouting the connector area behind the wall (Fig. b) and by welding (Figs. c and d).

Water tightness of the RD pile wall can be improved by sealing the space between RF connector and the adjacent pile pipe by welding after excavation has been completed, Figure 18c.

If water leaking through the connectors or sealant material in connectors prevents the space from being closed by welding, a flat bar/steel plate can be welded in front of the connectors and if necessary the gap between the connectors and the bar/plate can be grouted, Figure 18d.

When an RD pile wall is subject to clear water tightness requirements, for example, when the RD pile wall is installed in water or below the groundwater table, it is always recommended to use some sealing agent in the connectors. In such situations, the flow of water through the connectors is usually so strong that sealing by welding is either very difficult or impossible. Sealing agents that are not water tight during installation (for example, some urethane based agents) are not suitable for situations where strong water flow is expected, such as earth dam improvements.

The water tightness of the lower end of the RD pile wall greatly depends on the groundwater conditions and water permeability of the bedrock and the soil layer directly above it. With conventional sheet pile walls, it is often difficult to achieve sufficient water tightness of the lower end of the wall without a concrete beam and/or grouting the soil and bedrock, because the sheet pile walls cannot be extended to follow tightly the bedrock surface which allows the flow along the surface under the wall.

mill, or by using sealing agent which is applied on RF connector at the site, Figure 18a. When using a non-swelling sealant, the excess material is peeled out of the connector during the installation but it has no effect on the final water tightness. When working under cold conditions, the bitumen can be heated for example with propane torch prior to the pile installation to match the normal operating temperature. Excessive heating of the bitumen needs to be avoided, too high temperature breaks the structure of elastomers in bitumen. Water tightness can also be improved by grouting the area of the connectors behind the wall, Figure 18b. The results of water tightness tests on RM/RF connectors with different sealing agents are given in section 6.4.

When the piles of an RD pile wall are extended into the bedrock, they block the direct flow route of water below the lower end of the wall, which considerably reduces, or maybe completely prevents, the seepage of water into the area inside the wall. The depth of drilling to bedrock and the depth of the pile toes in relation to each other is of great importance. For larger pile dimensions ($d \geq 500$) it is recommended to have a minimum drill depth of 1.5 m to solid bedrock. For smaller dimensions ($d < 500$), it is recommended to have a minimum drill depth of 1 m to solid bedrock. It helps to achieve better watertightness, if adjacent piles can be extended as close as possible to same depth and if the connectors in piles can be extended as close as possible to the lower end of the pile. When the RD pile wall extends to the bedrock, the water tightness of its lower end can be ensured, if necessary, by grouting the annulus between the piles and the bedrock.

If excavation is extended into the rock surface using an RD pile wall, it is possible to build a concrete beam at the interface between the wall and the bedrock. If necessary, ground water flow across the bedrock can be prevented by sealing the bedrock under the retaining wall by grouting it through the pipe piles. If the lower ends of the pile piles in the RD pile wall are open, they may be used as pump wells to lower the ground water table.

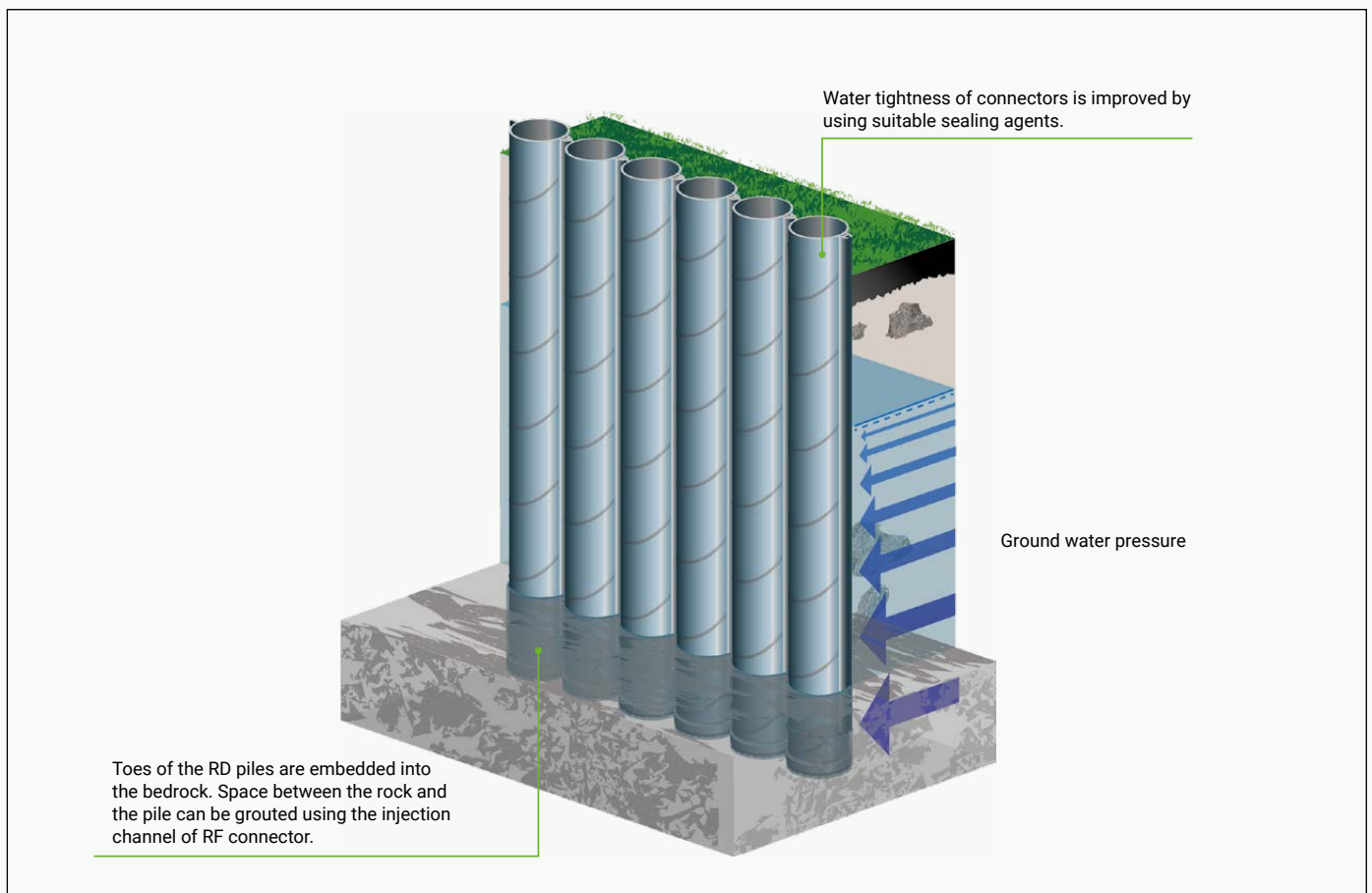

Figure 19. Watertight RD pile wall.

Back of wall drainage

In some situations, for example in harbor quay walls, there might be a need for limiting the water level behind the wall. If in such cases the drainage needs to be done through the wall, maximum diameter of 60 mm weep holes can be done through the RM/RF connectors.

Grouting

The injection channel of an RF connector can be used to inject the lower end of the RD pile wall. It allows grouting the area around the lower end of the connector. Figure 20a shows the principles of grouting.

If grouting is planned to be done through the injection channel in RF connector, it is recommended to equip the channel with grouting connector at the top, blocking at the bottom and grouting valves. Grouting is done after the drilling and internal concreting of the piles. Grouting hose is connected to previously mentioned grouting connector with G1/2" threads. Flushing with water is not usually necessary, but it might be useful to check the opening of the valves with water before grouting. If special matters like higher pressure are needed, water is not hardening like grout and thus allows more working time. Also in these circumstances the pumping of water is stopped after the valves have opened. Usually valves will open with 2 - 3 bar pressure. Although in selection of grouting pump and hoses there is a need to prepare for clearly higher pressures due to possible blocking of the valves. Grouting is done with mixture of water and cement, where recommended water/cement ratio is 0.5. Suitable cement to be used in grouting is for example rapid cement, CEM II/A-LL 42,5 R. Grout will fill the voids of drill cuttings in the annulus between the pile and the bedrock, and the drill cuttings will work like aggregate in concrete.

During grouting the mass will flow in annulus also parallel to the RD pile wall. When the grouting mass hardens, this may cause blocking of some grouting valves in adjacent piles. Therefore grouting needs to be tried from all the piles, even it might be impossible due to hardened grout. Recommended amount of grout is three times the theoretical volume of the annulus. The possible blocking of some valves can be covered with this excess grout material.

Grouting can also be performed from inside of the pile with the help of expanding packer inside the pile. The pile must not be able to rise due to the applied grouting pressure. If necessary, the pile can be rammed down again immediately after grouting. This is especially important with walls having significant vertical loads.

Different types of post-grouting can also be used on the unexcavated side of the RD pile wall to improve water tightness of the structure or to compact or reinforce the soil behind the wall. Grouting the background of an RD pile wall can be done by drilling or driving grout pipes behind the wall or to the joints of piles after the wall piles have been installed, Figure 20b. If necessary, grout pipes can also be attached to pile pipes before pile installation.

Water tightness of the section below excavation level can also be improved by grouting on the excavation side of the RD pile wall below the excavation level. The bedrock below the wall can be grouted through the piles of the RD pile wall. Grouting can be performed using e.g. cement- or bentonite-based grout.

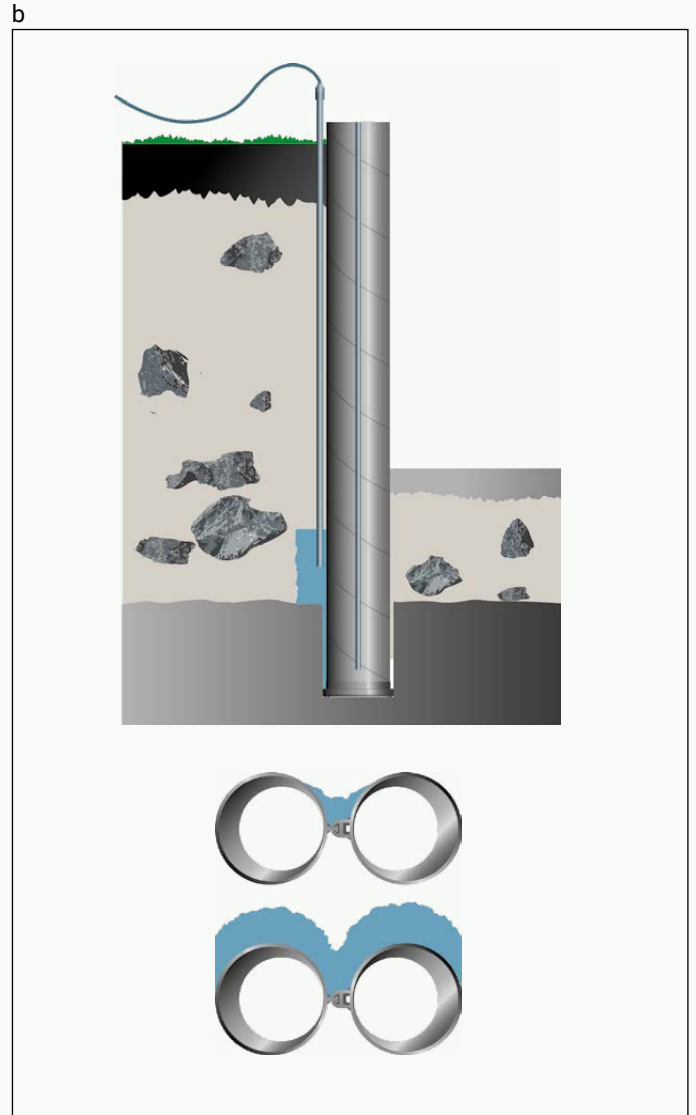
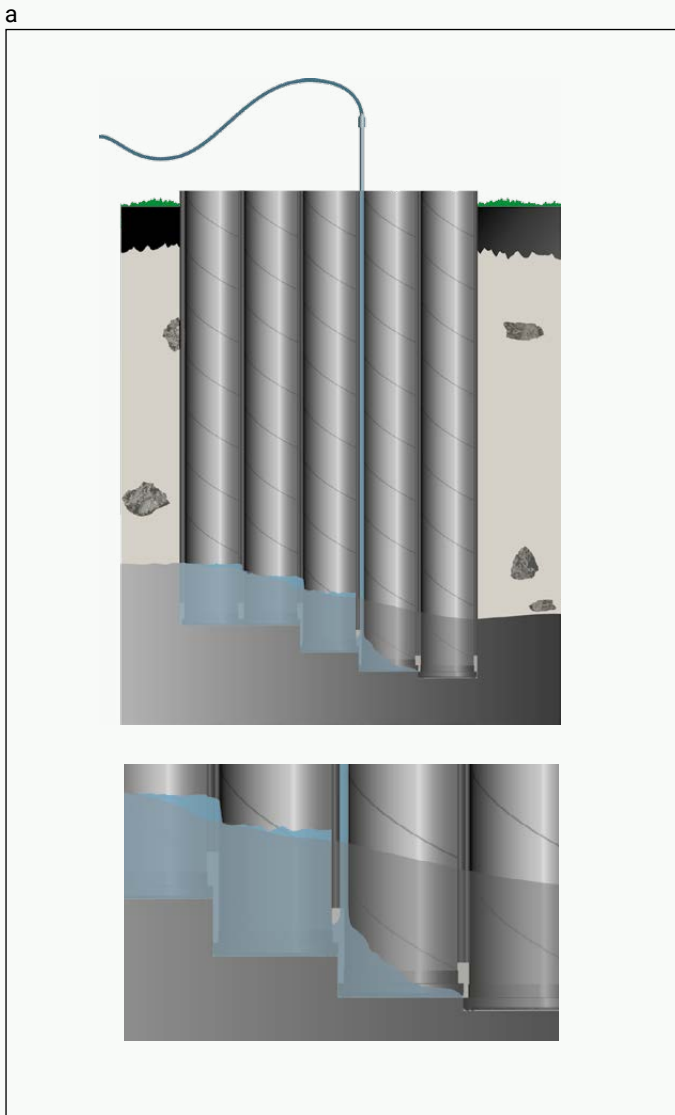

Figure 20a and 20b. Grouting behind and under an RD pile wall.

7.5 Other structural components

An RD pile wall may be supported internally by bracing if the opposite RD pile wall or other structure providing support is sufficiently close. In permanent, for example, a ground/base slab, the intermediate floors of a building or the deck structure of a trough may act as horizontal braces.

Walings and clamps are implemented using steel beams. The distance between the support levels is determined according to the acting earth pressure and the stiffness of the applied retaining wall.

With internally supported walls, there are several details to be considered during design and dimensioning of the bracing, such as deflection of the compression struts due to dead load, accidental impacts to the bracing system by machinery during excavation work, the concentration of loads centrally on struts in bracing joints, phasing and scheduling the excavation work and deformations of non-pretensioned supports during loading.

An RD pile wall can be supported externally by soil or rock anchors, or by tension rods attached to anchor plates as with other retaining wall structures. If external support is needed, an-

chors can be installed through the RM/RF connectors of RD pile wall if the diameter of the hole is less than 60 mm. If the support level can be located at the upper end of the RD pile wall, it is possible to make a separate console structure to avoid making holes for the anchors in the piles.

Surface treatments and linings

The piles for an RD pile wall may be delivered corrosion protected, Figure 22. Corrosion protection is provided by a protective paint system in compliance with relevant part(s) of EN ISO 12944 (Paints and varnishes – Corrosion protection of steel structures by protective paint systems) standard. Surface preparation, implementation and supervision of painting as well as tests on the coating are done in compliance with standard EN ISO 12944. The connectors and possible sheet piles of a Combi-wall may also be painted against corrosion. If protective painting is done before installation, the painted surface may get damaged during installation depending on the prevailing conditions.

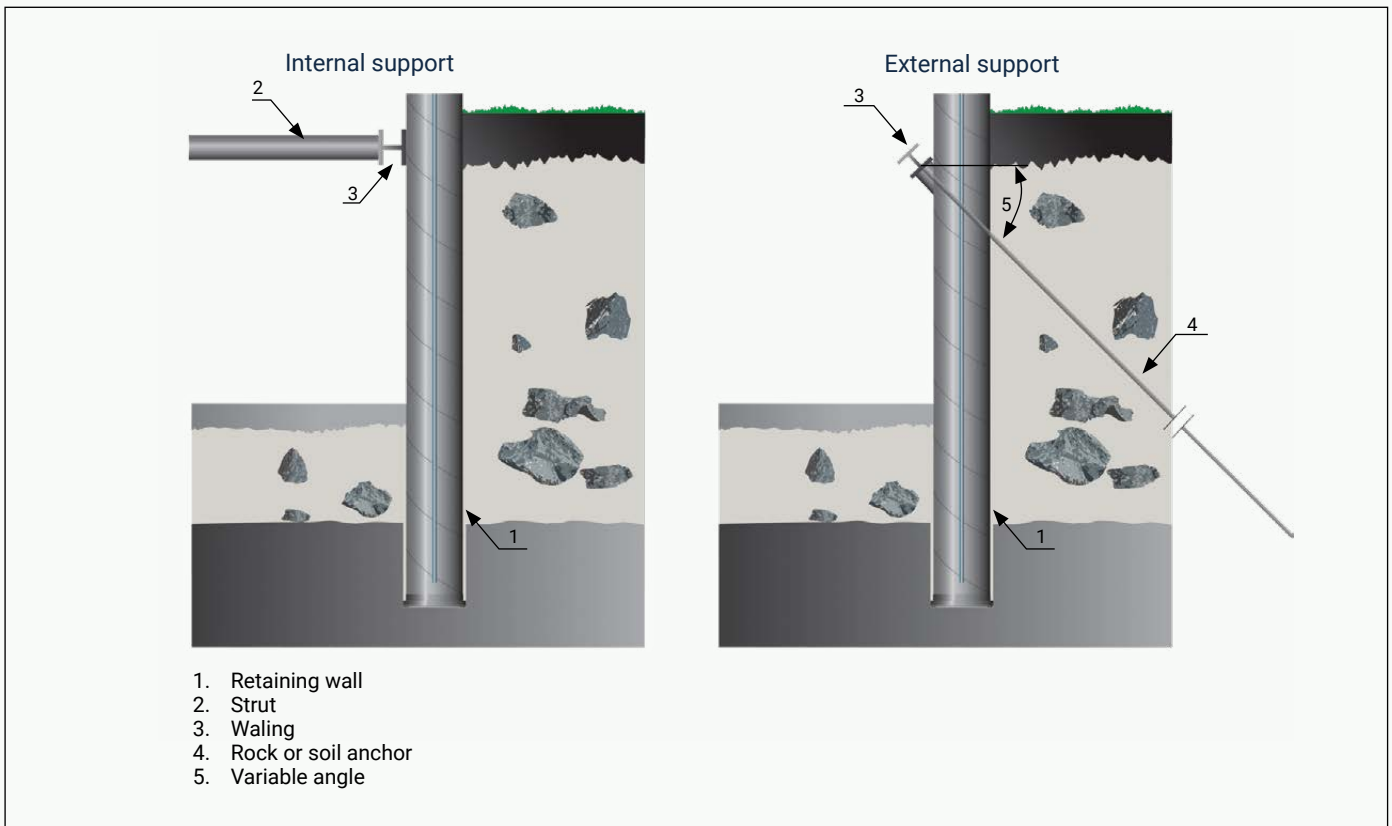

Figure 21. Internal and external support of an RD pile wall.

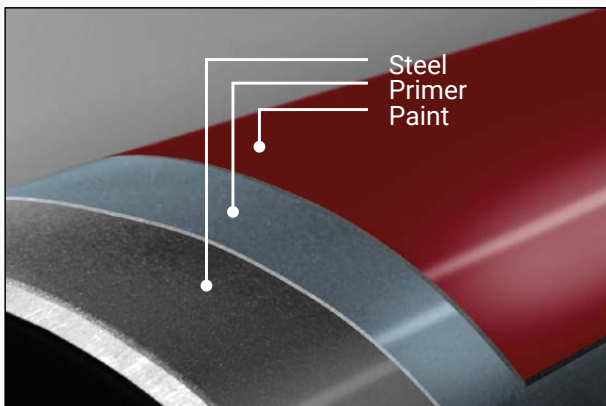

Figure 22. Coating of an RD pile wall by painting.

An RD pile wall can be fitted with various lining structures as necessary. Internal thermal insulation can be implemented, for instance, using sprayed polyurethane foam. Structures that need not be completely water tight can be lined, for instance, by shotcrete accompanied by installation of vertical drainage systems at the connectors.

If the RD pile wall is used as a bearing structure that may take a fire load, such as in underground parking facilities, fire protection rules and regulations must be followed in the design and implementation of such a structure.

When determining the time-temperature dependency in fire design, it is recommended to use fire simulations based on the actual fire load. The standard fire exposure overestimates the thermal stress caused by the temperature increase. When determining the structural resistance of RD pile wall, it should be remembered that only half of the structure is exposed to the fire.

If the unprotected RD pile wall does not have the required structural integrity in fire, the wall can be designed as a concrete-filled composite structure with or without reinforcement, which usually ensures adequate fire resistance. If this is not possible or more fire protection is needed, the wall can be sprayed with fire-retardant. Dimensioning of these fire retardant materials must be based on studied and approved material properties.

7.6 Working order

As a rule, the implementation of installation and the installation sequence ought to be considered already at the wall design phase so as to minimize the number of wall ends that need to be joined to each other.

Both wall tolerances and installation tolerances must be considered in design. In the design and implementation of wall lines tolerances must be taken into account especially if the wall incorporates frame columns.

Due to the longitudinal tolerances of the wall, implementation of a closed wall, i.e. a wall where the last pile is joined by an connector to the starting pile, is difficult. The exact pile spacing of a closed wall is not known before the other installation phases have been completed.

The wall ends can be joined by overlapping the end piles as shown in Figure 23. Piles of smaller diameter are used in the overlapping. The number of overlapped piles may be one or more, and the piles can be welded together at the point of overlap. Wall ends may also be overlapped using a pile that has no connector but has a normal size ring pit as shown in Figure 24. The pile is placed on the unexcavated side of the wall and is supported by installed wall piles.



Figure 23. Joining wall ends by overlapping

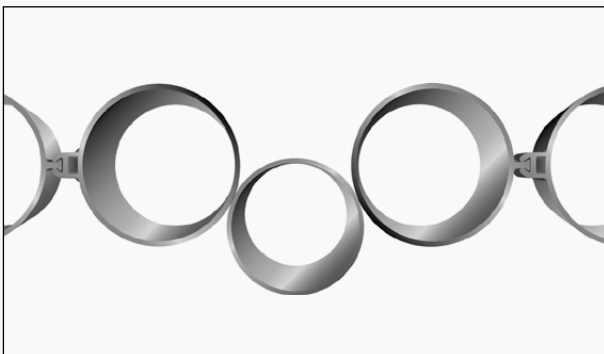

Figure 24. Joining wall ends by a loose pile.

Ensuring adequate water tightness of overlapping solutions may require grouting of the soil around joints. It is recommended to take into account the end joints and the RD piles required for them already during the RD pile wall design phase.

One possible solution for ensuring water tightness between wall ends is jet grouting. A jet grouting column can be done to the un-excavated side of the wall in-between the wall ends simi-

lar way as loose pile in Figure 24. Jet grouting may need pre-drilling in stony and hard soils.

An RD pile wall can be joined to a sheet pile wall if the interlock profile of the latter match to connectors of the RD pile wall. If the locking parts of the walls to be joined are different, a joint profile must be used to connect the different profiles. If an RD pile wall is extended by a sheet pile wall, a narrow E21 connector is attached to the RD pile as shown in Figure 25. If a sheet pile wall is extended by an RD pile wall, a wide E21 connector is used as shown in Figure 26.

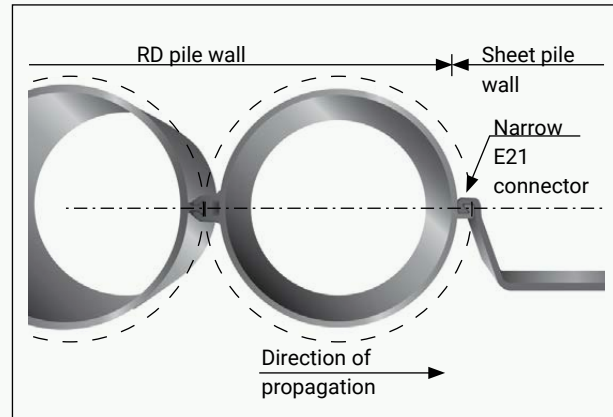

Figure 25. Narrow E21 connector in RD pile wall - sheet pile wall connection.

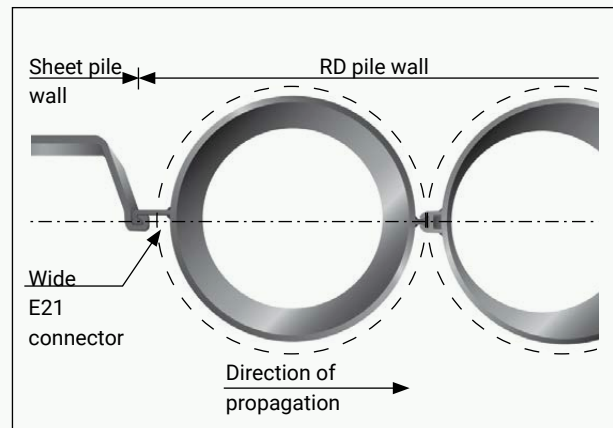

Figure 26. Wide E21 connector in a sheet pile wall - RD pile wall connection.

7.7 Special aspects to consider in design

Soil displacement

Soil displacement near RD pile walls is affected most by soil properties, but also by the drilling system, the implementation of the drilling work and the connector type. RD pile walls are installed using oversized ring bits so as to leave a theoretically empty space outside the piles. The size of the empty space depends on the pile size and connector type used.

In compact frictional soils, only minor soil displacement occurs near the RD pile wall. If compressed air flushing is used in the drilling, the empty space caused by the oversized ring bit is filled partly or entirely by drill cuttings. If the aim is to minimize displacement, compressed air and percussion force should be used only to the extent that flushing works and drilling progresses at a suitable rate.

In loose frictional ground, landfill and soft cohesive soil, settlement may take place in the immediate vicinity of the wall. Settlement may be caused by filling the empty space with the subsoil next to the wall. It may also be due to compressed air escaping outside the pile and resulting in loosening and disturbing the soil layers. Noticeable settlement may occur within half the pile length of the wall line. The extent of settlement greatly depends on the soil.

To minimize settlement, it is recommended to use a drilling system that allows the least amount of compressed air to escape into the soil around the pile.

Settlement of soft cohesive soils can be avoided by a technique where soil strata are penetrated by pressing or vibrating the open pipe pile with a variable frequency vibrator to the bottom of the soft soil strata. Thereafter, pile installation is continued by drilling. This technique requires the use of an integrated ring bit or a multi-wing bit.

When installing a micropile wall (RD220-RD320) a water-powered hammer with so called external flushing can be used. This causes the empty space to be filled by drill cuttings and keeps soil deformations small.

On sites sensitive to soil settlement and displacement, where special attention is to be paid to settlement management, it is recommended to start the work by performing tests away from the structures to be heeded or to perform a pilot installation before actual installation to be able to reliably assess soil settlements.

Corners

Pile placement at the corners of an RD pile wall must be addressed during the design phase to ensure connectors attached to the piles can be welded at the correct angles. Figure 27 shows alternative solutions for normal RD pile wall corners. Methods for making corners and angular changes in RD pile wall are dealt also in chapter 7.3.

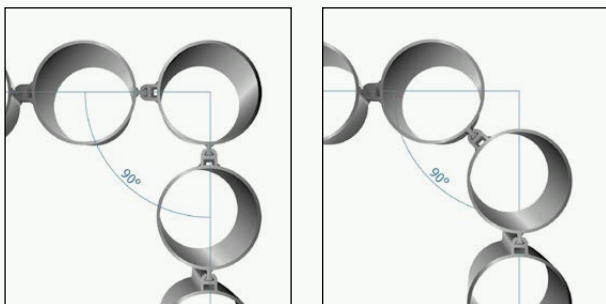

Figure 27. Examples of the pile placement at 90° corners of an RD pile wall.

Order of installation

If possible, the installation should be planned to begin from the longest pile towards the shortest pile. The reason for the installation order is the width of the RF connector. It cannot be installed deeper than the bottom of the previous pile. If such installation order is not possible and the pile has to be drilled deeper than the previous pile, this should be taken into account in the distance between the lower end of the pile and the lower end of the RF

connector. Typically, the connectors begin at 200-300 mm from the lower end of the pile, allowing a small difference between the depths of piles.

If there are existing structures / buildings in the vicinity of the wall that is to be installed, the space requirement of the drilling equipment should also be taken into account when designing the installation order of wall.

8 Execution of RD pile wall structures

Execution standard EN 12063 for sheet pile walls, combined pile walls, high modulus walls is followed in the execution of RD pile walls.

General requirements concerning drilling equipment are given in Design and Installation Manual for RR and RD piles.

8.1 General

An RD pile wall is installed by the centric drilling method using ring bits of a larger diameter than standard bits. The ring bit drills a hole larger than the pile to accommodate the pile's connectors. Table 3 shows the recommended ring bit diameters for different piles and connectors. In soft soil conditions where there are no stones or friction soil layers in ground, smaller diameter drill bits can also be used.

If the RD pile wall must also bear vertical loads, it is recommended the ring bit / casing shoe is at the bottom of the drilled hole. The ring bit / casing shoe must not be supported by the rock shelf unless the pile is filled with concrete or grout.

When using multi-wing pilot bits, the rockiness of the soil and sufficiently powerful drilling equipment must be taken into account. Penetration through rocky soil and boulders might occasionally be difficult and slow with multi-wing pilot bits. When leaving the piles of an RD pile wall in a moraine stratum, the stones in the soil may prevent the bit wings from closing and the drill bit from being lifted. Attention must also be given to ensuring sufficient rotation speed when drilling with multi-wing pilot bit.

Especially when using wing bits, but also when using ring bits, the compatibility of the tolerances of the pilot bit, the casing shoe and the pile pipe must be paid attention to. Particularly should be checked, if the tolerance between the head of the pilot bit and the casing shoe are suitable for the out of roundness tolerance of the pile pipe size in question.

As an alternative installation method, vibration or a combination of vibration and drilling can also be used. In this case, attention should be paid to the removal of possible obstacles on the surface, which will help to install an accurate wall.

8.2 Site preparation

The site must be prepared to ensure work can be done safely and efficiently.

Due to the height of the piling mast and long pile pipe, the drill rig has a high center of gravity. Good load-bearing capacity and flatness of the working platform are essential for safety at work. The

working platform must be designed and dimensioned at the design stage. If obstacles disrupting drilling are removed from the RD pile wall location, all excavations need to be filled and compacted carefully. The working platform must not subside during drilling.

The level at which pile drilling is initiated must not be below the caterpillar level of the drilling rig. Drilling from lower level than the caterpillar level (drilling to trench) is unstable and inaccurate. It can also reduce working platform stability causing it to collapse and the drilling rig to fall over.

8.3 Storage and handling of pile pipes

Pile pipes must be stored and handled with care on site to prevent any significant damage to pile pipe straightness, connectors and coatings. The storage and handling of piles on site are covered by a separate manual; *Pipes, piles and accessories. Recommendations for safe handling on site.*

Piles and their accessories must be inspected immediately after delivery to the site. A visual inspection is made to ensure the shipment corresponds to the order and consignment note. The steel grade and dimensions of piles are verified from product descriptions and markings on the pile pipes. Pile sections and accessories must correspond to the products specified in the designs. A faulty or wrong product must not be installed.

Piles and their accessories must be inspected once more before installation. Pre-installation inspection ensures that the piles have not been damaged during handling and storage on site.

Pile elements and pile pipes are usually erected by a lifting cable or similar attached to near the head of the pile. Special care must be taken during erection to ensure, for example, that the lifting equipment/chain remains attached to the pile. It is recommended that in pile erection the piling equipment positioned at the pile during erection so that it does not need to be moved except for minor adjustment when the pile stands upright in the piling equipment.

Stress from curvature caused by the deadweight of a steel pile is never a critical factor when lifting RD micropiles. With large diameter piles ($d \geq 400$), the length limit for piles that can be lifted from the head without closer analysis is 20 meters. The erection of longer piles must be planned case by case, taking into account the pile dimensions. Piling rig stability must be considered in erection, and the weight and reach limitations and instructions for the rig must be taken into account in lifting.

8.4 Welding and cutting of steel elements

The connectors are attached by welding to pile pipes at SSAB mill. The requirements and instructions given in EN 12063 for manufacturing of steel parts, considering for example tolerances and welds, are followed in manufacturing of steel pile elements, see also Chapter 9. The requirements and instructions given in EN 12063 must be followed also in welds etc. applied to pile elements on site.

The tolerances of the connectors attached to the RD piles are according to Clause 8.4.13 and Figure 24 of EN 12063, shown also in Figure 28. The connectors in figures are shown in 180° positions, but same tolerances are applied also to connectors in other angles. The method to check the position of the connectors is described in EN 12063. The allowed tolerances are:

- position of the connector, when L and R are measured along the outer circumference of the element
 - L \pm 10 mm
 - R \pm 10 mm
- maximum relative deviations
 - 2 % angle deviation
 - 0.2 % straightness requirement of connector length

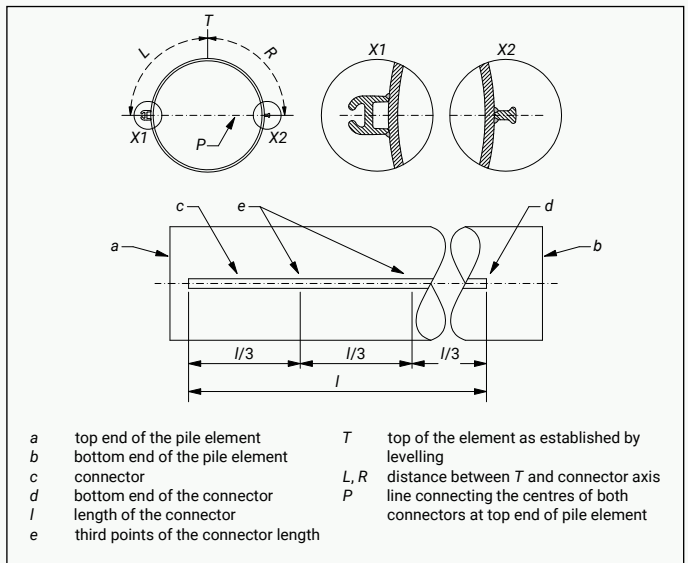

Figure 28. Positions of check points for tolerances of connectors.

RD piles with connectors can be spliced by welding if the required pile length exceeds the length that can be installed using the available pile drilling equipment. The piles intended to be spliced are to be specified already when placing the order so that they can be matched and marked as pairs. This makes splicing of piles on site much easier.

Splice welding of a pile pipe with connectors on site conditions requires special attention. Most important is to align the connectors in upper and lower element in order to allow sliding of RM and RF connectors of adjacent piles inside each other's. Small deviation can be allowed between locations of upper and lower pile pipes, but not between upper and lower connectors. Also, it must be ensured that no angle change occurs between the pile elements. With piles to be lengthened, the attachment welds of the connectors to the piles are not done to the very end of the pile elements. This allows removal of short pieces of connectors to enable full circumferential splice welding of the pile pipe. After splice welding of the pile, the pieces of the connectors can be welded back to ensure water tightness of the wall. Design and installation manual for RR and RD piles gives more information on requirements and also instructions on welding of RD piles. Appendix 5 of the manual has info on required preheat and hold times before commencing NDT. Requirements on the welds, i.e. weld classes and amounts of NDTs, on different Execution Classes are given in Table 12.

Use of backing in splice welding of pile pipes can be sometimes impossible. This is due to aligning of the connectors instead of the pile pipes. Small deviation in alignment of pile pipes can prevent use of backing.

Table 12. Requirements for welds on RD pile walls according to EN 12063

Type of welded assembly	Type of joint and reference to figure in EN 12063	Type of weld	Joint preparation	Allowable welding processes *	Execution Class	Description / qualification of welding procedure	Quality level according to EN ISO 5817	Type of testing **	Extent of testing							
General																
Lengthened piles	Butt joint, Figure 13 a	Single-V or single bevel butt weld	Single-V (1.3) or single bevel (1.9.2) preparation with or without backing strip according to EN ISO 9692-1	111, 114, 121, 122, 131, 135, 136 and 138 according to EN ISO 4063	EXC1	-	EN ISO 3834-3	EN ISO 3834-3	To be agreed	To be agreed						
											EXC2	EN ISO 15609-1	C	Visual UT	100 % 10 % of welds	
																EXC3
Attachment of connectors to piles	T joint, Figure 16	Single or double fillet weld	Square preparation (3.1) according to EN ISO 9692-1	111, 114, 121, 122, 131, 135, 136 and 138 according to EN ISO 4063	EXC1	-	-	EN ISO 3834-3	To be agreed	To be agreed						
											EXC2	EN ISO 15607	EN ISO 15609-1	C	Visual PT or MT	50 % 10 % of welds
Lengthening of connectors, non-structural welds	Butt joint	Single-V or single bevel butt weld	Single-V (1.3) or single bevel (1.9.2) preparation without backing strip according to EN ISO 9692-1	111, 114, 121, 122, 131, 135, 136 and 138 according to EN ISO 4063	EXC1	-	-	EN ISO 3834-3	To be agreed	To be agreed						
											EXC2	EN ISO 15609-1	D	Visual	100 %	
																EXC3
Water tightening welds on connectors, non-structural welds	Butt joint, Figure 23	Single-V butt weld	-	111, 114, 121, 122, 131, 135, 136 and 138 according to EN ISO 4063	All	-	-	EN ISO 3834-3	To be agreed	To be agreed						
											No requirement, can be agreed	To be agreed	To be agreed			
														No requirement, can be agreed	To be agreed	To be agreed

*) 111 = Manual metal arc welding

114 = Self-shielded tubular cored arc welding

121 = Submerged arc welding with solid wire electrode

122 = Submerged arc welding with strip electrodes

131 = MIG welding with solid wire electrode

135 = MAG welding with solid wire electrode

136 = MAG welding with flux cored electrode

138 = MAG welding with metal cored electrode

**) UT = Ultrasonic testing

PT = Penetrant testing

MT = Magnetic particle testing

When the RD pile has reached its target level, the pile section remaining above ground can be cut off. The need to cut depends on the used drilling equipment. If the RF connector at the pile to be installed can be connected with the RM connector in the previously installed pile which may extend quite high above ground level, there is no need to cut the previous pile to facilitate the work. The final cutting of piles is done perpendicularly at the cut-off height according to design. Piles may be cut, for instance, by a flame cutter or a plasma cutter.

The rules of procedure must be paid particular attention where cutting RD piles in special situations where the part to be removed can not be normally lifted / fell directly away (for example if piling rig and drill string are still attached to pile while the pile is cut). In such case the part which will be removed must be "peeled open". Due to the manufacturing methods of pile pipes, there might be stresses left in them. Therefore cutting of pile by "peeling" must be made in sequences shown in Figure 29. Longitudinal cut, for the whole length of the part to be removed, must be made first. After the longitudinal cut has been made, the pile can be cut normally from the design cut-off elevation. Cutting must be started from the point where longitudinal cut has ended.

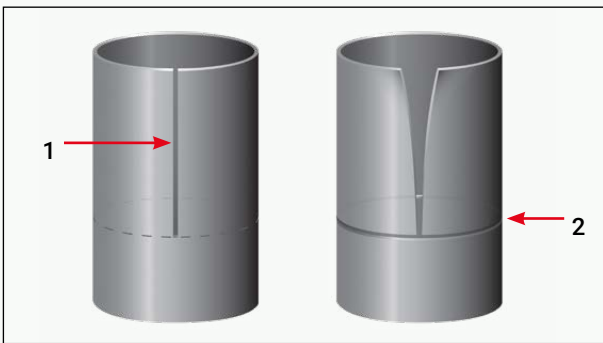

Figure 29. Cutting an RD pile by "peeling"

8.5 Drilling of pile pipes

Installation of an RD pile wall places no special demands on the features of the installation equipment, which means that normal pile drilling equipment can generally be used. However, it must be ensured that jaws and other parts of the equipment can accommodate the connectors welded to the sides of the piles. It is recommended to have such supports in jaws of drill rig, where the RM connector profile can be supported in two directions during installation of the pile. At the direction of the wall line the support helps during positioning of the pile and during beginning of the drilling, placing the RF connector to correct position when connecting to RM connector. In transverse direction to the wall line the support prevents the pile from rotating during installation. It is important to guide the pile pipe with jaws to ensure the RD pile wall is straight. Use of the longest possible pile elements to minimize splice welds facilitates pile wall installation.

If highly accurate alignment is required, it is recommended that the piles are installed through a guide frame built at ground level. Guide frame is installed while making piling platform.

To ensure drilling accuracy and stability during the drilling of RD piles and the RD pile wall, the base of the piling mast must be supported firmly to working platform and the DTH hammer with drill string must be eccentric to pile pipe. An unstable drilling position

can cause inaccurate pile locations, connector jamming and tearing, or casing shoe detachment if the longitudinal axis of the piles does not remain parallel.

First pile

Installation of an RD pile wall is usually started at the point where the bedrock surface is at the deepest. The next pile can be drilled deeper than the previous one, but this must be taken into account in the length of the RF connector. The next pile can be drilled only as much deeper as the RF connector is missing from pile end, as shown in Figure 30.

During installation of the first pile, it must be ensured that the connectors stay aligned as planned and the pile pipe does not rotate. The best way to ensure the position of the first pile and the direction of the connectors is to support the connectors to the jaws of the drilling rig. Special attention must be paid to inclination of the first pile to ensure wall straightness. Pile inclination must be taken into account also when installing subsequent piles. If a pile is askew, this can damage the connectors or it may try to "fall" the wall. The next pile always supports to the previous pile which keeps them better aligned. Where the line of wall needs to be especially accurate, use of a guide frame is recommended.

The first pile of an RD pile wall must not have an RF connector, see Figure 11. The drill bit makes a hole where only an RM connector can fit. Even if the installation continues in one direction from the first pile, the first pile usually has two RM connectors. The reason is better handling of out-of-roundness of the pile during welding of the connectors. If installation continues in both directions from the first pile, two RM connectors must be attached to the first pile at desired angles.

Subsequent piles

An RD pile wall can be installed either in the direction of the wall line by backing up the drilling rig, or from the side, depending on the equipment used. The wall can be installed from either side or in either direction. However, installation is always done so that an RM connector is on the side of direction of installation. Installation may also begin from the middle of the wall line or from a corner using a pile onto which two similar RM connectors have been attached.

When starting drilling of pile, the RF connector must always be connected to the RM connector of the previous pile. As the distance between the lower end of the RF connector and the lower end of the pile grows large this may be impossible, causing problems for positioning and aligning of the pile and for starting of the drilling. By anticipating the change in drilling depth as the wall progress, the difference in depth can be divided into several piles. Alternatively, excavation of a small pit to the location of the pile to be drilled enables starting of drilling from lower level and also enables connection of connectors before drilling. Use of temporary lengthening of previous pile will also enable connecting of RF connector in the beginning of drilling. After the pile is drilled, the temporary lengthening part of the previous pile is removed.

When an RD pile encounters a large stone, boulder or bedrock, the pull down force is kept low and rotation speed is increased. This reduces the tendency of the pile to change direction during drilling. It also ensures a reliable installation process as stresses and friction on the connectors remain low.

On a sloping bedrock surface, it is advisable to install the piles of an RD pile wall in the direction of upward sloping bedrock so that the connectors can be extended close to the toe of the pile pipe. If it is assumed that the bedrock surface declines in the direction of installation, and a pile has to be drilled deeper than the previous one, the RF connector must not extend to the toe of the pile, see Figure 30. If a RF connector extends to the toe of a pile, it will collide with the ring bit of the previous pile or with the bedrock preventing installation to lower level than the previous pile. In the case of pile walls whose lower section is subject to water tightness requirements, the connectors should extend as low as possible.

For instance, if it is desired to install a pile 3 metres deeper than the previous one, the RF connector must end at least 3 metres before the pile toe, Figure 30. Since that requires installing the pile for the first 3 metres without the pile being joined to the previous one by a connector, use of an installation frame is recommended to keep the piles aligned and to allow connecting the connectors. Alternatively the top soil at the location of pile to be installed can be dug away and the installation of pile can be started from lower level. This enables joining the connectors together before the beginning of drilling.

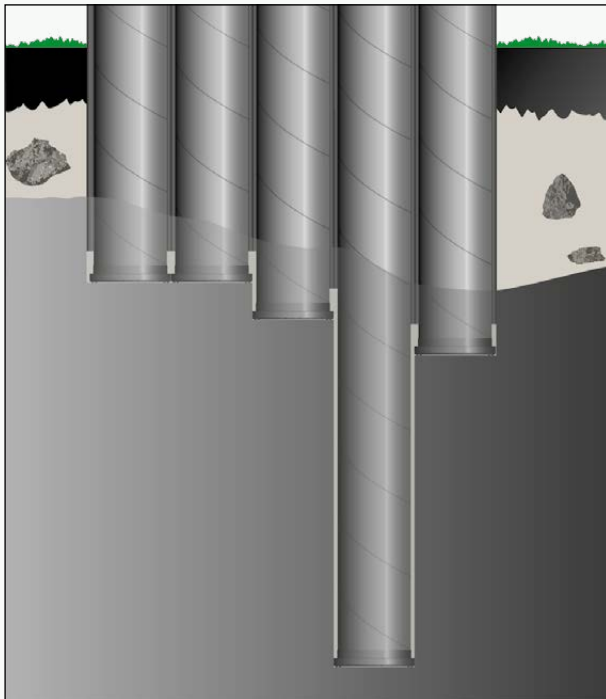

Figure 30. Ending of a connector when a pile is required to be installed at a lower level than the previous one.

Safety of work must be ensured at all stages of piling. Pressure may build up inside installed piles during drilling, and its sudden discharge up along the pipe constitutes a hazard. Pile ends must be closed securely against pressure shock and due to risk of falling.

8.6 Tolerances regarding plan position and verticality

Inaccuracy of an RD pile wall is usually small due to the drilling method. Stones and boulders in ground do not usually cause inaccuracy the positioning of an RD pile wall. If necessary, RD pile wall accuracy can be improved by using a guide frame during installation.

Inclination of an RD pile wall needs extra attention if the wall forms a closed structure or if some other things impose stricter tolerances on wall inclination. If the RD pile wall is not joined at its ends to other structures or if perpendicularity is not otherwise important, the tolerances are similar to drilled piles.

Unless otherwise stated in design, the measurement accuracy of the location of pile pipes before and after installation is 10 millimeters. Figure 31 shows the definitions for tolerances used in construction.

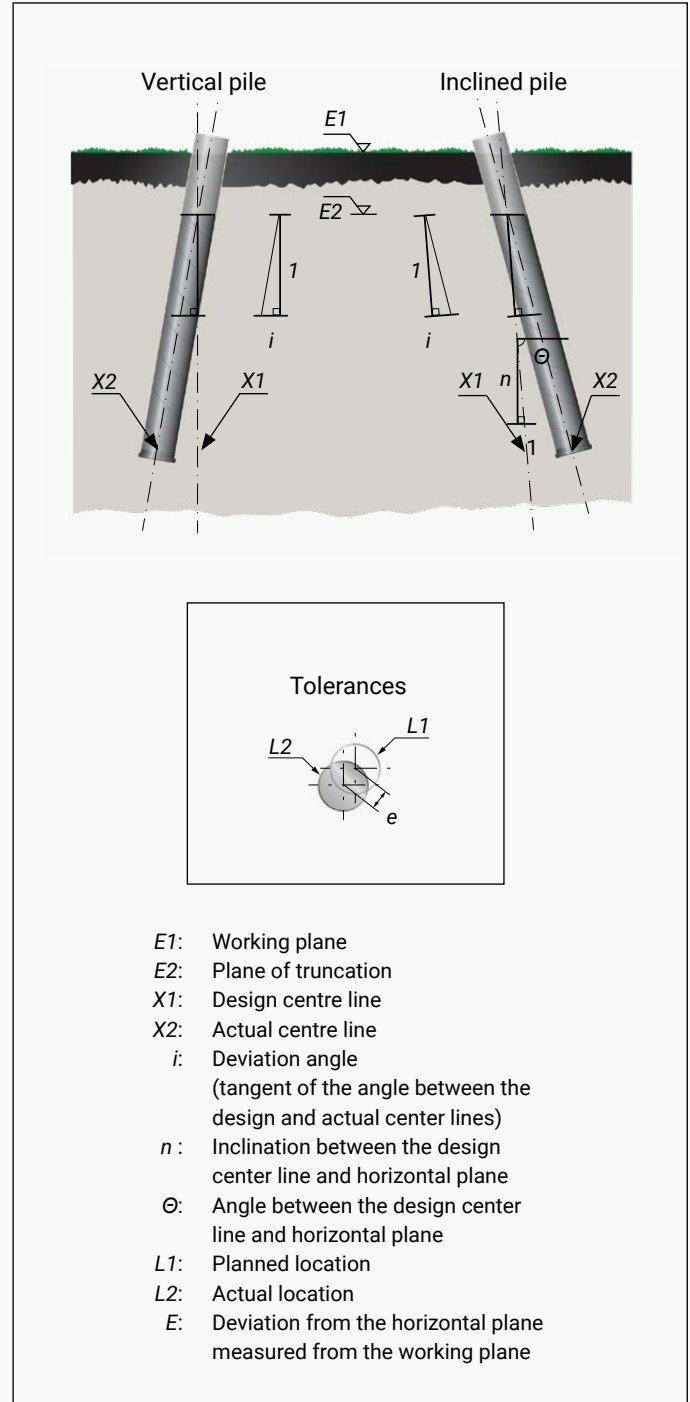

Figure 31. Definitions for geometrical tolerances in construction

Tolerances can be agreed separately before installation if structural demands, soil conditions or drilling equipment used imposes stricter tolerances or allows larger tolerances than those given here. Table 13 shows the recommended tolerances for RD pile walls.

Table 13. Recommended tolerances for RD pile walls

Type of RD pile wall	Plane position of pile top	Inclination tolerance upright piles or inclined piles with inclination of $n \geq 15$ ($\theta \geq 86^\circ$)	Inclination tolerance inclined piles with inclination of $4 \leq n < 15$ ($76^\circ \leq \theta < 86^\circ$)
Temporary structure, no vertical loads	≤ 50 mm	$\leq 2\%$ (0.02 m/m)	$\leq 4\%$ (0.04 m/m)
Permanent structure or vertical loads	≤ 25 mm	$\leq 1.5\%$ (0.015 m/m)	$\leq 2.5\%$ (0.025 m/m)

8.7 Pile pipe position correction during drilling

Drilling as an installation method and the stiffness of RD pile pipes reduce the tendency to incline forward during installation. However, inclination may occur while using large, powerful drilling rigs. Inclination can be reduced by using a guide frame of sufficient stiffness and stability, and by reducing pull down speed. These methods ensure reliable installation with low stresses and friction to connectors.

8.8 Installation of anchorages

An RD pile wall can be supported externally by soil or rock anchors, or by tension rods attached to anchor plates in the same way as other retaining wall structures. The hole needed for the anchor is drilled, for example, with diamond drilling. Efforts are primarily made to drill an anchor hole in the center of the pile, but if necessary, a hole can also be drilled at the connectors. In demanding conditions, soil and water leakage through the hole requires special attention, for example, when the hole is under the groundwater table or when soil granularity is very fine. Fast curing concrete or a separate collar around the anchor casing can be used to control leaking soil and water. Measures needed after anchor stress must be considered when using fast curing concrete. When making a watertight RD pile wall, also water tightness of the connection between the anchor casing and bedrock must be taken into account.

8.9 Walings and struts

Execution standard EN 1090-2 for steel structures is followed in the execution of walings, struts and connections.

Walings and compression struts are made of steel. Hollow sections or HEB-profiles can be used.

Detailed designs and drawings are needed from all joints between the walings and struts. All splices must be located as shown in the drawings.

Loads must be centralized on compression struts. This is why special attention needs to be paid to cutting the heads of compression struts and for joints between compression struts and walings.

All supporting structures need to be firmly joined to the RD pile wall to ensure they do not detach due to contacts from machinery or wall movement.

8.10 Excavation, filling, drainage and de-watering

Excavation is made in accordance with the excavation plan, each support level at a time. Sufficient safety must be in place during excavation work to ensure the sloping edge of the excavation pit does not collapse. While excavating below working level, the weight of the excavator and any working platform load the edge.

Construction work in excavation is usually done in dry conditions, in which case the bottom of the excavation should be kept dry. As minimum, the excavation pit should have rainwater and meltwater drainage.

When lowering groundwater in an excavation pit, groundwater lowering and excavation stages must be coordinated with each other. Groundwater lowering must be verified from observation wells in the excavation area.

8.11 Extraction of pile pipes

The piles of an RD pile wall installed in temporary structures may be reused several times. If necessary, RD piles are to be filled with soil before extracting them so as to avoid major settlements or hazards. After the extraction of a temporary RD pile wall, the underlying subsoil and possible structural layers must be compacted to the density required by the site.

Extraction may be done, for instance, by a vibratory hammer. The impact of any integrated ring bit on pile extraction should be considered in the case of RD pile walls to be extracted.

8.12 Rock dowels and anchor bolts

The lower end of an RD pile wall can be supported on the bedrock by drilling all or some of the piles into it. The lower end can also be supported on bedrock by drilling separate anchors, rock dowels or smaller drilled piles through the pile pipes into the bedrock. When the piles are installed in the bedrock, a concrete beam at the lower end of the RD wall is not normally needed to support the lower end of the wall. If the RD pile wall is not extended into the bedrock, it is supported by passive earth pressure in the same way as a conventional retaining wall structure.

Owing to the high bending stiffness of the RD pile wall, the distance between the support levels can be made longer compared, for instance, to a sheet pile wall. By extending the RD pile wall sufficiently into the bedrock and by grouting behind the connectors, if necessary, the retaining wall can be made to act partly as a mast structure of high bending moment stiffness, which reduces the need for support levels. The RD pile wall can be supported by internal or external supports.

8.13 Sealing

Water tightness of the connectors used in RD pile walls can be improved using the methods described in sections 6.4 and 7.4. The final level of water tightness depends on the sealant material and method used, installation work, soil conditions and the hydrostatic pressure on different sides.

Besides sealing the connectors, the soil behind an RD pile wall can be grouted to make it watertight as shown in section 7.4. Grouting can be done for example through the injection channel in the RF connector, by using a separate injection channel or by jet grouting.

Grouting can be done for the whole length of the pile by perforating the injection channel in the RF connector. Based on test grouting, the maximum distance between holes is 1 meter and distance from uppermost hole to ground level is about 2 meters. The amount of grout used must be clearly bigger than theoretical amount needed; based on tests it should be at least three times bigger. Grout will flow first to those areas with easy access. When those areas have filled, the grout will flow to other areas. To avoid the injection channel filling with soil during drilling of the piles, the bottom end and the holes in it must be plugged.

Grouting between the bedrock and RD pile wall is inspected visually when excavation reaches the bedrock surface. If necessary, tightness can be improved by soil grouting, concrete beam, jet grouting or bedrock curtain injection.

8.14 Surface treatments and linings

An RD pile wall can be delivered with coating as described in section 7.5. Possible damage to the coating depends greatly on the installation work and soil conditions.

When an RD pile wall is coated on site after installation, it can be coated with several different paints or masses as needed. The pile surface must be cleaned as required by the coating employed.

An RD pile wall can also be covered with different panels or cassettes. Lining can be attached either directly to piles or to a separate frame. When using a separate frame, possible deviations in the RD pile wall can be straightened.

9 Supervision, testing and monitoring

In its operations, SSAB follows procedures that comply with the requirements of the EN ISO 9001 (Quality management systems. Requirements) quality management system and the EN ISO 14001 (Environmental management systems. Requirements with guidance for use) environmental management system. Quality management systems ensure the functioning of processes from raw materials procurement to delivery of the end product to the customer.

SSAB steel pipe piles are made of high-quality steel produced at the company's steel mill in Raahé. Large diameter (\geq RD400) steel pipe piles are manufactured by spiral welding and small diameter piles (\leq RD320) by longitudinal welding. Connectors are welded simultaneously to both sides of the RD piles on an automated production line. Special attention has been paid to control of deformations of steel pipes due to welding the connectors.

The steel piles used in SSAB RD pile wall are CE marked products and have been granted European Technical Assessment ETA 12/0526.

Technical delivery conditions

The technical delivery conditions of piles comply with standard EN 10219-1 (Cold formed structural welded hollow sections of non-alloy and fine grain steels – Part 1: Technical delivery requirements). Dimensions and tolerances comply with standard

EN 10219-2 (Cold formed welded structural hollow sections of non-alloy and fine grain steels – Part 2: Tolerances, dimensions and sectional properties). With small diameter pile pipes \leq 350 mm the tolerances are stricter and European Technical Assessment ETA 12-0526 is followed on those. A material certificate in accordance with EN 10204 (Metallic products. Types of inspection documents) type 3.1 for the pile material is provided.

The connectors are according to EN 10248-1 (Hot rolled sheet piling of non alloy steels. Part 1: Technical delivery conditions). The tolerances, instructions for welds and requirements for inspections given in EN 12063 are followed on fastening welds of connectors.

9.1 Supervision

Supervision of the all work related to a retaining wall structure must be done at least according to Chapter 4 of EN 1997-1. In addition, piling work is supervised according Chapter 7 of EN 1997-1. Supervision of the construction process, including workmanship, and any monitoring of the performance of the structure during and after construction, must be specified in the Geotechnical Design Report.

The plan should specify the type, quality and frequency of supervision, which should be commensurate with the:

- degree of uncertainty in the design assumptions
- complexity of the ground and loading conditions
- potential risk of failure during construction
- feasibility of implementing design modifications or corrective measures during construction.

In addition, the plan included in the Geotechnical Design Report must state acceptable limits for the results to be obtained by supervision.

Construction work must be inspected on a continuous basis and the inspection results must be recorded. Records shall be maintained of at least the following:

- sequence of inspections
- content of each inspection
- critical values of transformations, forces and water levels

9.2 Testing

Ground condition testing must be done according to Chapter 3 of EN 1997-1.

Possible pile load tests for the RD pile and the RD pile wall primary and secondary elements must be carried out according to Chapter 7.5 of EN 1997-1.

The requirements and instructions given in EN 12063 are followed for testing of welds in pile elements. For other steel structures, the requirements and instructions given in EN 1090-2 are followed.

9.3 Monitoring

Different phases of RD pile wall installation must be monitored. The monitoring program must be carried out in accordance with the Geotechnical Design Report. Process description and implementation plan must be according to EN 1997-1.

If project is located in a built-up area, the ground vibrations and noise levels arising from construction work must be followed up and registered regularly. In addition, the impact of piling on

any nearby easily damaged buildings or unstable slopes must be observed. Observation methods can be, for instance, measurement of vibrations, capillary water pressure, and transformation or tilt. Measurement performed according to local practice to ensure the results can be compared to the criteria for the area.

Observation frequency must be defined and agreed before starting piling work. Measurement records must be prepared at agreed intervals and be available at the site until piling has been completed, after which they will be archived.

All equipment used for follow-up and monitoring must be appropriate and calibrated.

All deviations to the plans arising whilst work is being carried out must be reported and documented.

An experienced drill operator can estimate how solid the rock is by observations made during drilling and the settlement speed of the pile pipe. Based on these observations, the responsible foundation engineer can estimate the sufficiency of the geotechnical resistance. If needed, geotechnical resistance can be measured by a static or dynamic load test.

Displacements of already installed piles must be followed continuously during installation work. After piling work has been completed, pile location displacements must be measured at cut-off level. If displacement is larger than allowed in the plans, the responsible foundation engineer will analyze how this excess affects stresses arising in the piles and superstructures. The decision as to whether or not these piles can still be accepted is made based on this analysis.

The completed structure will be documented after piling. Documentation must include the pile locations and dimensions and the level of the upper and lower heads of the piles. Measurement must take place as soon as possible after installation. The accuracy for location is 10 mm, for level 5 mm, for inclination 0.5 % and for direction 5 gon.

Verification reports of the piles and any other construction documents shall be archived as required by contracts and statutory requirements.

Pile straightness must be inspected and documented after installation. For the piles that are empty and dry after installation, inspection can be made by lowering a torch with measuring tape into the pile pipe. Piles failing to meet straightness criteria are reported to the responsible foundation engineer, who will then decide on any further action.

Where the level of ground-water or free streaming water is a critical parameter in design, the levels must be monitored and measured with sufficient frequency to provide a reliable impression. It is recommended that ground-water level or pore-water pressure continues to be monitored after installation until it is verified that there are no adverse impacts.

The horizontal deviation in the upper end of retaining wall must be monitored regularly in predefined positions. Accuracy must

be sufficient to compare the results to the designed values. When a retaining wall is located near easily-damaged buildings or sensitive equipment, the following points at least must also be considered:

- measuring displacement at a certain depth
- measuring the subsidence of these buildings
- measuring the anchoring forces.

10 Construction site documentation

All significant quality assurance measures must be documented. Inspection documents must be dated and signed. Documents must be filed in the construction site quality folder, which must be updated continuously. Once construction has been completed, the contractor must submit a copy of the quality folder to the developer.

10.1 Installation phase worksite documents

Worksite documents related to the supervision, testing and monitoring and measuring of permanent retain wall structures referred to in chapter 9 must be available at the construction site.

10.2 Final phase worksite documents

The final worksite documents must include following information:

- the actual locations of the retaining wall and the additional structures remaining in the ground in relation to the reference point or reference lines
- a list of significant information related to use, maintenance and inspection of the structure
- information about the groundwater level and pore-water pressure given in the design report
- special instructions concerning actions to be taken after installation has been completed where such action is deemed necessary due to observations made during installation
- maintenance instructions for drying systems, methods to be used and frequency of maintenance
- restrictions regarding additional loads behind the wall
- displacement during the construction of the retaining wall
- incidents adversely affecting installation and how the effects of these were dealt with
- record of any damage to nearby buildings
- results of penetration and loading tests.

11 Special requirements

Until such time as similar European standards are available, local national standards, instructions and definitions must be followed in matters concerning

- worksite safety
- safety of working methods
- legality of the manual working phases and inspections to be done during excavation
- reliability and safety of the piling equipment and other apparatus and tools used in piling and excavation work

11.1 Safety

Requirements of the safety regulations as well as European and national standards and quality criteria must be complied with in the manufacture of retaining wall structures.

Piling machinery and equipment must comply with standards EN 16228-1, -2 and -7 (Drilling and foundation equipment. Safety).

Piling or excavation work must comply with safety aspects applying to:

- worksite safety
- operational safety of the piling rig and other equipment and tools used in piling
- safety of working methods.

Particular attention must be paid to:

- all work phases requiring working near heavy machinery and equipment, and heavy tools
- the danger related to open excavation pits / open pile pipes
- manual work phases and inspections to be performed inside RD pile wall excavation pits
- lifting and moving of piles and reinforcements.

Manual excavation work must be kept to minimum. It must also be limited to dry soil conditions, where the soil is naturally stable, and where the walls of the excavation pit are constantly supported.

11.2 Impact on surrounding buildings and installations

If there are structures and installations in the vicinity of the construction site which are vulnerable to constructional damage, the condition of these structures must be carefully established and documented before work begins.

Disruption and possible damage to the surroundings caused by piling work must be kept to a minimum and below the specified limit values.

Disruption and environmental nuisance may include

- shifting and / or compaction of the soil layer
- disturbance of the soil and increase of pore water pressure
- vibrations
- noise
- soil, water and air pollution.

The nature and extent of any disruption or environmental nuisance depends on the:

- location of the piling site
- soil and ground water conditions at the site
- piling method
- working order and work phase.

National discharge standards and other national standards concerning the protection of the surroundings must be complied with where no European standards are available. Suitabil-

ity of the materials used in the environment concerned must be proved. This must be agreed with the customer, who confirms the use of materials and supplies.

11.3 Noise hindrance

Special precautions shall be taken to ensure noise levels remain within the limits provided by international or national regulations.

If persons in the vicinity of the piling site are likely to be exposed to noise, the expected noise level must be estimated or demonstrated by comparable experience from similar sites or by test piling. Assessment of the acceptability of the piling work is done based on these estimations. If necessary, the noise level should be monitored during piling work to ensure the noise level remains within the agreed limits.

At worksites, where noise level exceeds 80 dB, hearing protection must be used.

Outsiders must be prevented from entering the noise impact area.

11.4 Permeability of retaining walls

The water tightness of an RD pile wall is greatly affected by the soil properties. It can be generally said that at low soil permeability (fine-grained soils) and moderate differential water pressure across the wall (<50..80 kPa), the amount of water penetrating the connectors is negligible. With increasing differential water pressure and highly water-permeable soils, the probability of leaks through the connectors increases.

Water tightness of an RD pile wall can be improved by applying a bitumen-based sealing agent, applied hot, on the RF connector either in factory or on site or by using sealing compound that expands in contact with water, Figure 18a. Water tightness can also be improved by grouting the connector area behind the wall, Figure 18b.

Water tightness of the RD pile wall can be improved by sealing the space between RF connector and the adjacent pile pipe by welding after the excavation has been completed, Figure 18c. If water leaking through the connectors or applied sealing material prevents the section being closed by welding, a flat bar/steel plate can be welded in front of the connectors, Figure 18d.

The water tightness of the lower end of the RD pile wall greatly depends on groundwater conditions and water permeability of the bedrock and the soil layer directly above it. When the piles of RD pile wall are extended into the bedrock, they block the direct flow route of water through the lower end of the wall. This considerably reduces, or perhaps completely prevents, the filtration of water into the area inside the wall. When the RD pile wall extends into the bedrock, the water tightness of its lower end can be ensured, if necessary, by grouting the space between the piles and bedrock.

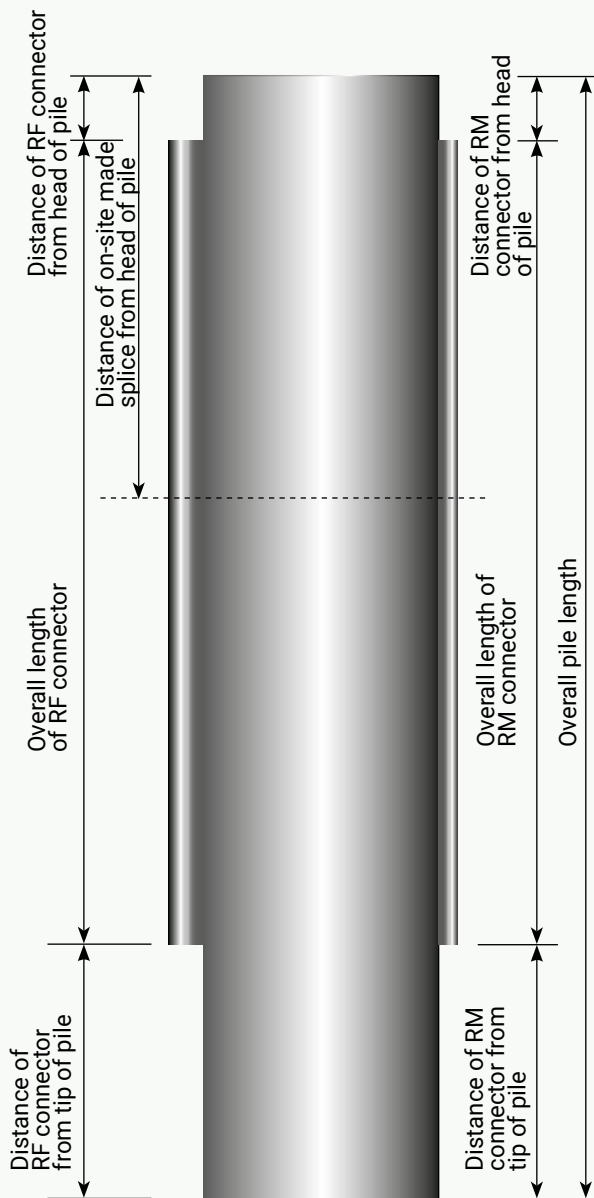

Pile identifier: _____

Pile size: _____

Wall thickness: _____

Pile steel grade: S355J2H
 S440J2H
 S460MH
 S550J2H

Connector type: RM/RF
 E21

Splicing on site: yes
 no

Necessary end bevels must be made known when placing order.

Pile accessories: Grouting pipes
 Other accessories

A plan of all accessories must be presented.

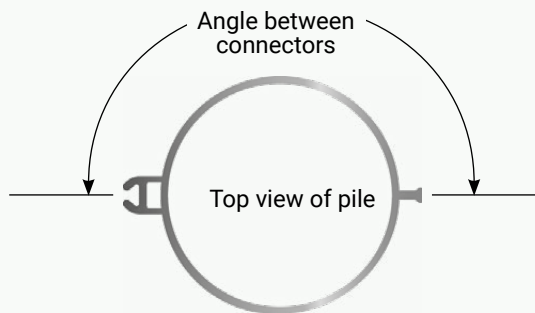

In deviation from the assumption:

RM connector
 No connector

In deviation from the assumption:

No connector

The pile situation plan for the RD pile wall must show:

- Piles with individual identifiers; code or colour
- Installation starting points
- Direction of installation
- Possible wall-end joints and details

Basic principle:

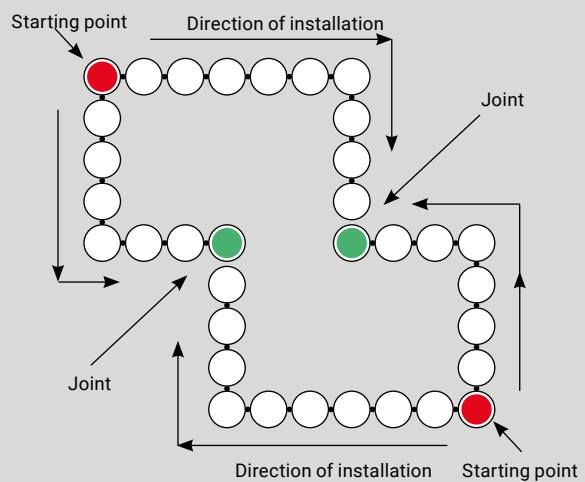

Figure 32. Data required for manufacturing of pile elements of an RD pile wall.

SSAB is a Nordic and US-based steel company that builds a stronger, lighter and more sustainable world through value added steel products and services. Working with our partners, SSAB has developed SSAB Fossil-free™ steel and plans to reinvent the value chain from the mine to the end customer, largely eliminating carbon dioxide emissions from our own operations. SSAB Zero™, a largely carbon emission-free steel based on recycled steel, further strengthens SSAB's leadership position and our comprehensive, sustainable offering independent of the raw material. SSAB has employees in over 50 countries and production facilities in Sweden, Finland and the US. SSAB is listed on Nasdaq Stockholm and has a secondary listing on Nasdaq Helsinki. Join us on our journey! www.ssab.com, [Facebook](#), [Instagram](#), [LinkedIn](#), [X](#) and [YouTube](#).

DISCLAIMER

The data and commentary in this document is for general information purposes only. It is provided without warranty of any kind. SSAB Europe Oy (or any of its affiliates) shall not be held responsible for any errors, omissions or misuse of any of the enclosed information and hereby disclaims any and all liability resulting from the ability or inability to use the information contained within. Anyone making use of this material does so at his/her own risk. In no event will SSAB Europe Oy (or any of its affiliates) be held liable for any damages including lost profits, lost savings or other incidental or consequential damages arising from use of or inability to use the information contained within. The size range and technical properties of SSAB piles as well as the content of this document are subject to modifications without notice.

Copyright © 2024 SSAB. All rights reserved. SSAB and SSAB brand names are registered trademarks of SSAB.

SSAB
Harvialantie 420
13300 Hämeenlinna

Puh. 020 5911

www.ssab.fi/infra

The SSAB logo is rendered in a bold, dark blue, sans-serif font. The letters 'S', 'S', and 'A' are connected, and the 'B' is separate. The logo is positioned in the bottom right corner of the page.